

X-YACHTING



HIGHLIGHTS FROM THE 2016 X-CUPS

Solent, Ostsee and Holland Cup race reports

THE NEW X4³ & X6⁵

Full details on the new "X" Range

MARMARIS RACE WEEK

X-Yachts carnival in Marmaris

X-YACHTS QUALITIES

What makes an X-Yacht Special

VICTORIA

2017

When every moment counts

Every EPEX sail is unique and custom built. Designed in-house at Elvstrøm Sails in Denmark with the aid of leading edge sail design software in one workflow from design to finished membrane.

EPEX is the only membrane sail on the market with an extended warranty against delamination!

Check out the unique technology behind EPEX:
epex.dk

Elvstrøm Sails A/S
Paul Elvstrøms Vej 4
DK-6200 Aabenraa
elvstromsails.com

DESIGNED
AND MADE IN
DENMARK

THE
WORLD'S
BEST
MEMBRANE
SAILS

www.elvstromsails.com



Contents

2017 edition

X-YACHTING 2017

- 05** Welcome
- 06** X-Yachts News
- 10** X-Yachts Qualities

Xcruising

- 30** Next Generation Cruising
- 34** Xc 35
- 38** Xc 38
- 46** Xc 42
- 52** Xc 45
- 58** Xc 50

Xperformance

- 64** New Performers
- 74** Xp 33
- 80** Xp 38
- 86** Xp 44
- 92** Xp 50
- 102** Xp 55

Xrange

- 112** Simply X
- 116** X4
- 124** X6

X World

- 134** Xp 44's dominating around the world
- 136** Solent Cup Report
- 138** Ostsee Cup Report
- 139** Holland Cup Report
- 140** X-Yachts Carnival in Marmaris

Dealers

- 145** Meet the team: International dealers



10



30



64



136

X-Yachts
WORLD CLASS SINCE 1979

X-Yachts A/S · Fjordagervej 21 · 6100 Haderslev · Denmark

Tel: +45 74 52 10 22 · Fax: +45 74 53 03 97

info@x-yachts.com · www.x-yachts.com

Printed by ScanPrint, January 2017 · Cover image: Jesús Renedo

X

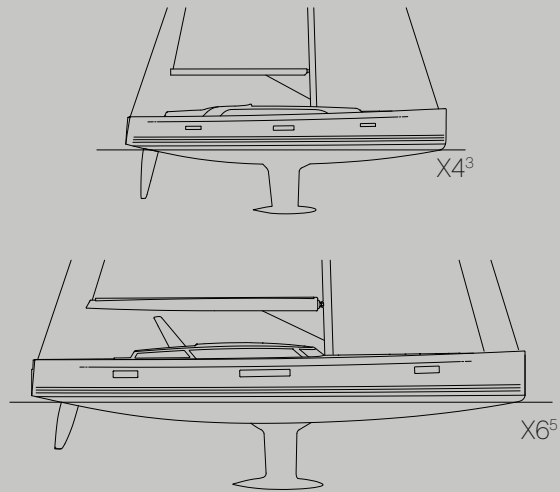

Our new range of contemporary performance cruisers.

Xc

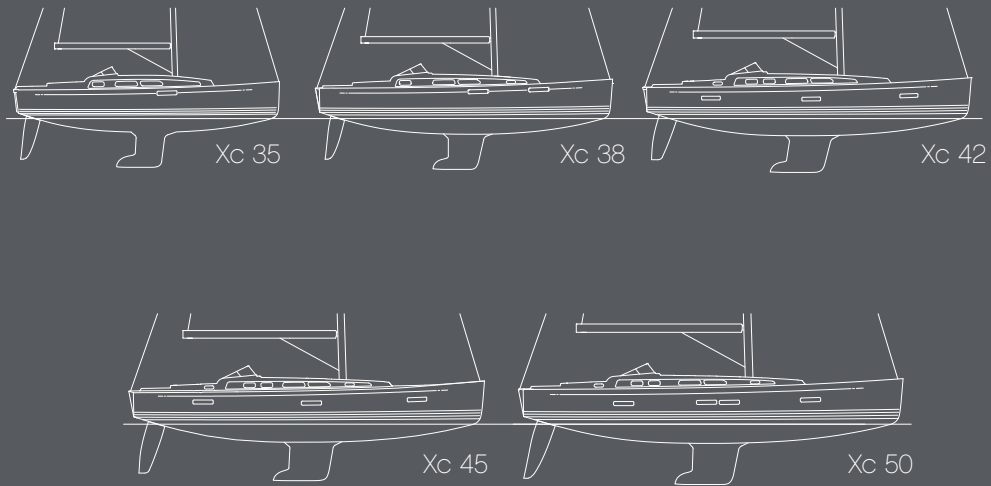

Dedicated long distance cruising yachts with enjoyable handling under sail.

Xp

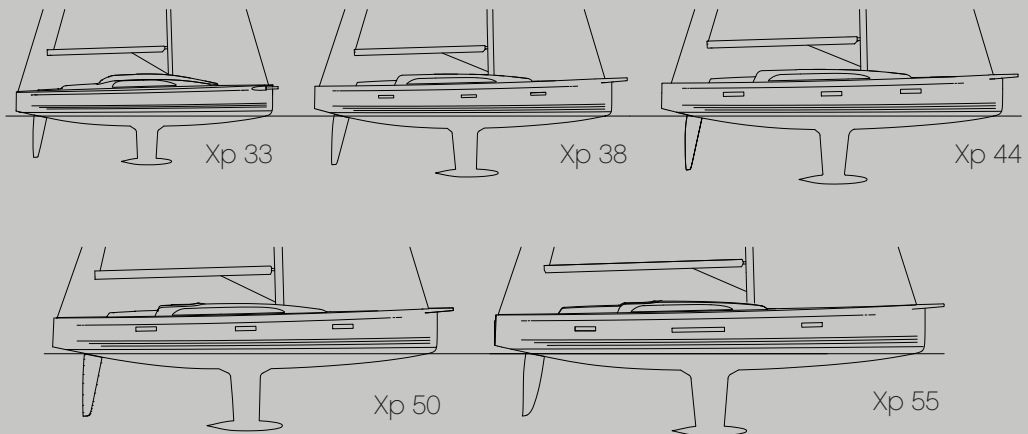

Sleek, comfortable yachts combining world-class performance and cruising amenities.



WELCOME TO THIS 2017 EDITION OF X-YACHTING.

We say good bye to 2016, a year, where we experienced the "future" coming back, where we launched the two first babies in the new pure "X"-range, namely the all new X4³ and all new X6⁵.

The X4³ and X6⁵ will both get more siblings in the future, for 2017, we have our hands full already.

X-Yachts is also busy building the timeless range of dedicated cruising yachts, the Xcruising range, which was updated very recently and keeps being refined.

In 2017, we will also be busy delivering the firsts of a new edition of the performance oriented Xperformance range models. (see page 64)

These new Xp models are basically developed on the same DNA as the originals, but improved and modified to further develop the performance as well as will sport newly detailed interiors based on the latest interior design experiences.

With this X-Yachting magazine, we strive to give the readers valuable and interesting information about what X-Yachts is all about.

I wish you an enjoyable 2017, and hope to see you at one of the X-Yachts sailing or social event throughout the season.

Kind regards

Niels Jeppesen

Founder, CEO



X-News



X6^s followed by X4^s at their sea trial this summer in Haderslev.

X-YACHTS LAUNCHES THE X4^s AND X6^s

It has been a very exciting year at the X-Yachts yard with the launch of the first two models in the new X range.

The X4^s and X6^s were both launched in the early summer and after completing a series of test sails in Denmark went off to join their new owners.

Following several glowing test reports in yachting magazines sales of both yachts are doing very well with 4 X6^s and 25 X4^s sold to date. You can read more about these 2 exciting new models on page 112.

DOUBLE X-YACHTS APPRECIATION FROM THE ROYAL YACHT SQUADRON

Every year The Royal Yacht Squadron presents the Camrose Trophy to a member who has written the best log of their cruising journey.

This year not one, but two X-Yacht owners entered. 1st Prize went to Sarah William Maltby who owns Xc 50 "Freebird", while 2nd were John & Aafke Oldridge who own Xc 45 "Perseverance".

You can read both stories in full on the X-Yachts website.



Camrose price winners at the RYS.



Xp 44 Garlix at anchor in Fakarava, French Polynesia.

XP 44 S/Y "GARLIX" COMPLETES WORLD ARC

The Round the World Rally saw 24 yachts set off from St Lucia on an epic cruise together around the world making stops at Colombia, Panama, Galapagos, French Polynesia, Suvarrow, Niue, Tonga and Fiji, Vanuatu, Australia, Mauritius, Reunion, South Africa, St Helena and Brazil before heading back up to the Caribbean.

Owners Jens and Dagmar from Germany have said they have had a wonderful time on their trip and are currently in St Lucia having a well earned celebration with the other yachts.



X-Yachts crew party at Club Marítimo Varadero.

ARC 2016

The world famous ARC transatlantic event set off on the 20th of November from Las Palmas de Gran Canaria to St Lucia in the Caribbean.

Setting a yacht up for a trip such as a transatlantic crossing can be an enormous task. Extensive safety checks and provisioning must all be carried out in the days before the start to ensure everything on board is in full working order and is set up to deal with the demanding Atlantic conditions for days on end.

This year X-Yachts sent 3 members of the X-Yachts team down to Las Palmas to help the owners in the run up to the start of the event. Klaus, Jensen, X-Yachts Service Assistant since 1998 who was able to help with all technical systems and general maintenance and preparation on board. Rocio Gandarias (naval architect) and Georgie Eggleton (marketing manager), who between them they have a huge amount of offshore sailing experience having completed 8 transatlantic's and many years as professional yacht crew,



X-562 Teamgeist set off to the start of the ARC.



The youngest X-Yachts crew onboard their X-452 Solskinn.



The X-Yachts crew on hand to help in Las Palmas

and so were able to offer some helpful and practical advice to the crews as well as helping with any last minute jobs on board.

On the Thursday before the start X-Yachts hosted a reception at Club Marítimo Varadero in Las Palmas for the crews of the nine X-Yachts taking part in this years rally. The atmosphere amongst all of the crews was buzzing with anticipation of the adventure they are about to undertake.

They were all very pleased to mingle with a group of like-minded X-Yacht sailors, make new friends and share some stories of their journey so far as well as exchanging some useful tips for the crossing.

All the participating X-Yachts have now safely arrived in the sunny Caribbean, where another adventure begins.

X4³ WINS “BEST FULL-SIZED CRUISER UNDER 50 FEET” AWARD BY CRUISING WORLD (USA)

Cruising World Boat of the Year judge Tim Murphy said: “It has, I believe, the best structure of all the boats in this category, it’s a galvanized steel grid frame in the bilge of the boat. It gives the boat incredible stiffness. It’s also built with epoxy, which is the best resin you can build boats out of. They paid strict attention to the weight

of the boat. I think they’ve largely hit their mark of providing more cruising comfort than their full-on performance boats do. And yet during our sea trials, it was clear they’d kept it a really nice sailing boat.”

The X4³ has also been nominated as European Yacht of the Year in the Luxury Cruiser category.



X-Yachts Spain will this year be sending out their 2 exclusive Xp 50's to Bermuda to join the action at the 35th Americas Cup.

Throughout the entire build up and during the Americas Cup itself X-Yachts Spain will have “Victoria” & “Roberta” positioned right in the centre of the action at the iconic Royal Bermuda Yacht Club.

X-Yachts Spain are offering this once in a



Maryna Kurashevych



Greg Williamson.

NEW DEALERS IN UKRAINE AND SOUTH CAROLINA (USA)

X-Yachts continues to expand internationally as two new dealers, Maryna Kurashevych in Ukraine and Greg Williamson in Charleston, South Carolina, join the team.





Join X-Yachts Spain at the 35th Americas Cup in Bermuda.

lifetime opportunity for you to come to Bermuda and experience not only some unforgettable sailing in the beautiful turquoise waters, but also to get up close to the latest generation AC yachts as they battle it out in this legendary event.

The 2 Xp 50's will be in Bermuda during May and June and are offering a selection of charter packages from one day skippered cruises, luxury 5 day charters or 2 boat corporate event charter which includes

match racing, training, and team building as well as an unrivalled view of the AC racing.

During this time there is whole host of events taking place on the island including the Super Yacht Cup, J Class Cup, the Louis Vuitton Cup and of course the Americas Cup.

If you would like to join these two exceptional yachts and one of the biggest yachting spectacles in the world this summer then

now is your chance.

For further details please contact:

X-Yachts Spain & X-Yachts Sailing,

www.x-yachtssailing.com
+34 691390958



Photo: Yasuhiro Chatani





X-Yachts Qualities

With over 35 years of experience there is a reason why X-Yachts have established an enviable customer loyalty, it is in a word quality.

From the long heritage of designers and naval architects that really understand what a true sailing yacht should be, fanatical attention to detail and a constant drive for innovation and a build quality second to none.

The result, beautifully designed and built yachts that give **Superb Sailing Pleasure** to the knowledgeable owner that understands the difference.

Every detail of an X-Yacht, from the hull lines through to the world-class craftsmanship, stem from this idea.

The difference between X-Yachts and other yacht builders come from how the yachts are designed, built and specified technically. Production cost is not the main priority at X-Yachts, instead features and equipment are chosen, no matter the cost, to ensure all models excel in key areas.

Safety, Performance, Sea Keeping, Build Quality & Luxury.

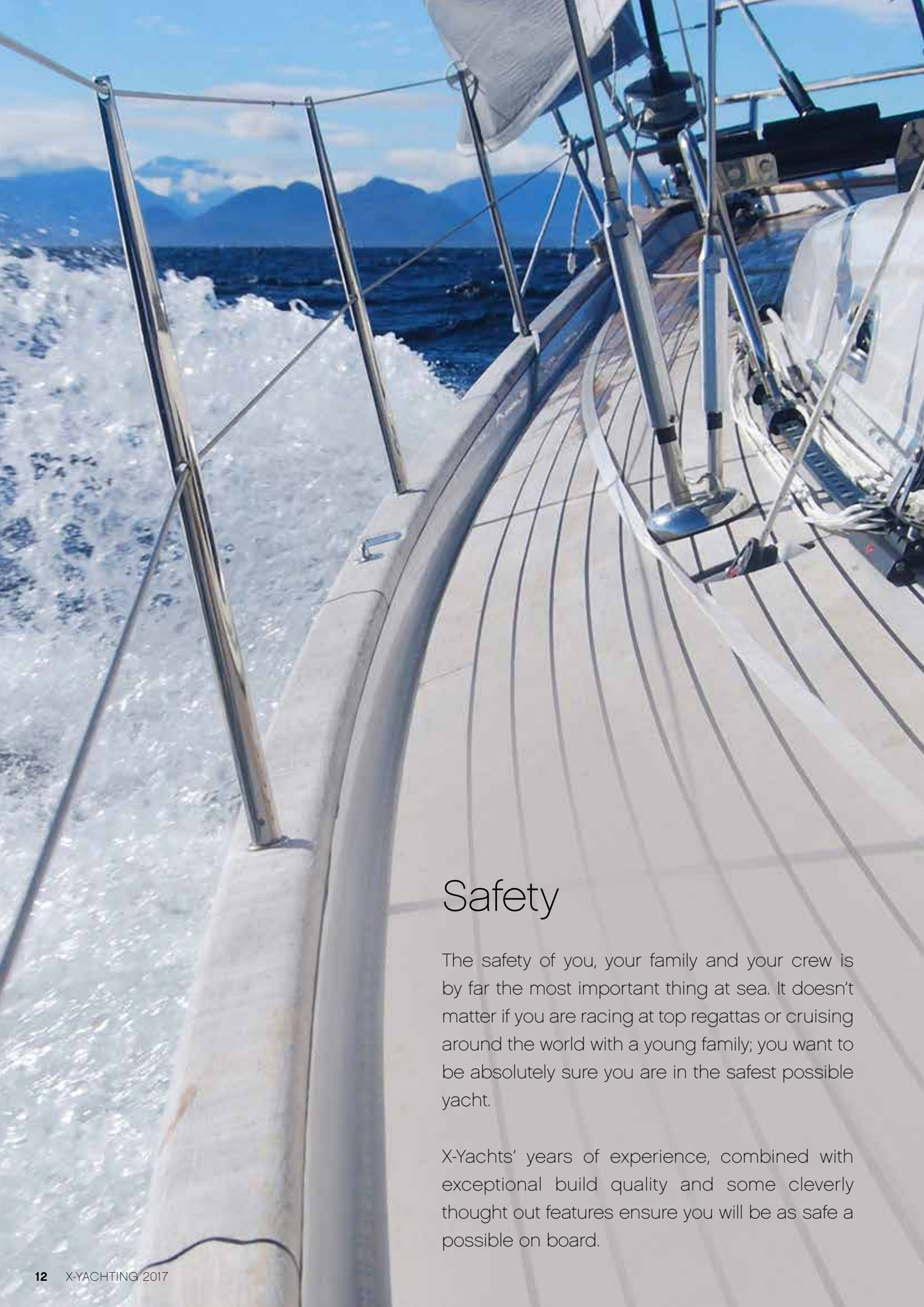

Safety

The safety of you, your family and your crew is by far the most important thing at sea. It doesn't matter if you are racing at top regattas or cruising around the world with a young family; you want to be absolutely sure you are in the safest possible yacht.

X-Yachts' years of experience, combined with exceptional build quality and some cleverly thought out features ensure you will be as safe a possible on board.

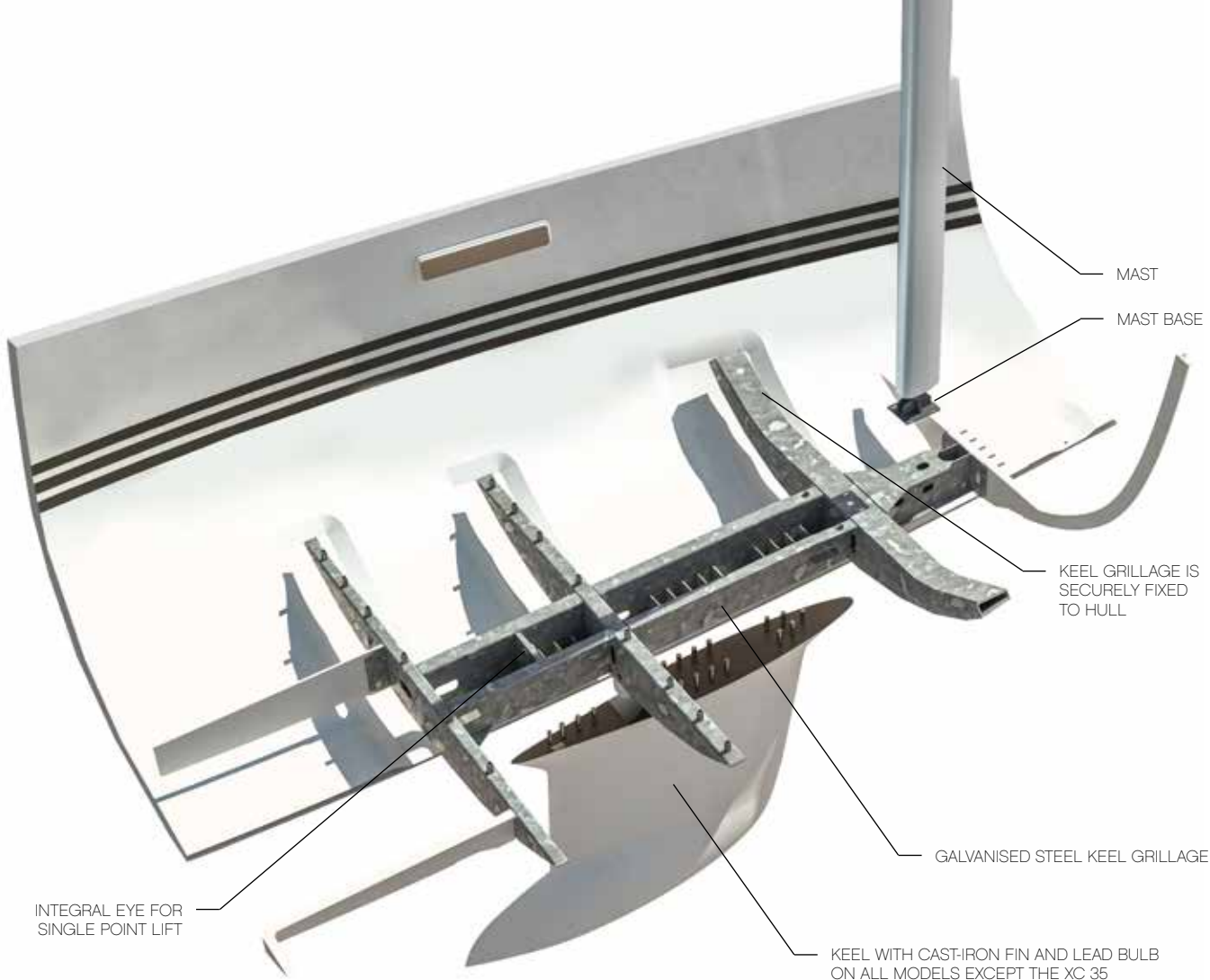

Keel Grillage

At the heart of every X-Yacht is the keel grillage structure. X-Yachts pioneered the galvanised steel hull girder back in 1981, which offers superb reassurance and safety.

Its primary role is to spread keel and mast loads into the hull and it also enables the yacht to withstand extreme shock loads from grounding or an impact with a submersed object.

This system has proved phenomenally successful and a refined design of the original system is still used in the Xc and X range today. In the Xp range where weight is of more importance carbon fibre replaces the steel structure giving amazing strength at a reduced weight without compromising on safety.

The keel grillage used in both the Xc, Xp and X ranges also provides a rigid

foundation for the floorboards and furniture in the saloon and in larger models allows for tanks to be securely mounted between the girders.

The keel grillage also provides a secure lifting point which allows the entire yacht to be safely lifted with a single strop through a deck fitting or hatch.



The problem with conventional “top-down” furlers starts at the top.

THE TOP DOESN'T START.

THE REFLEX™ FURLING SYSTEM IS HERE TO CHANGE THAT.

If an asymmetrical or code-style sail is to furl evenly and completely, the head swivel at the top of the rig must feel the torque from the furling drum way down on the deck and reflexively begin to turn. This is not an easy design challenge, and the reason most current units perform unevenly. Top-to-bottom, the Reflex system works to transfer torque to the top—where beautiful furling begins.

Photo © Ed Kukla / Starboard Films



REFLEX DRIVE UNIT: Powerful large diameter drive sheave. Unique quick-release design lets one unit furl all your kites.



REFLEX HEAD SWIVEL: Responsive new geometry starts winding sail immediately when you pull the furling line.



REFLEX TORSION CABLE: Polyester core inside tightly woven stainless. Transfers torque to the head swivel 2x better than anything we've tested.

AT THE **FRONT** **HARKEN**®
www.harken.com/Reflex



Performance

At X-Yachts we always strive to optimise both performance and comfort, and we believe that they go hand in hand.

A yacht that sails efficiently, accelerates well, heels less, and punches through

waves better, is a yacht that will give you the most comfort, is safer, and will deliver a completely enjoyable trustworthy sail whatever the weather.

On an X-Yacht you will be able to cover ground quicker in any conditions, giving

you more time to enjoy yourself in port, at anchor, or possibly beat that storm front you needed to get ahead of or simply to make the most of your time on board.

Vertical Weight Distribution

XYachts are often assumed to be light-weight yachts, which is understandable due to the racing heritage; in reality X-Yachts are often slightly heavier than competitors.

Weight is not necessarily an issue, it's how it is distributed that is important.

What X-Yachts have learnt from their rich racing heritage is a strong emphasis on optimum weight distribution.

Starting at the very early stages, and throughout the design of each project weight is minimised and positioned low whilst carrying as much weight as possible in the lead keel bulbs.

As such we create a yacht with a very low centre of gravity, directly resulting in greater righting moment at all points of heel.

Therefore an X-Yacht can carry a bigger sail plan for better performance in light to medium winds. In stronger winds, when the sail plan is reduced, the greater righting moment is of huge benefit.





Sea Keeping

Too often emphasis is given to the comfort of a yacht only at anchor and not enough to the comfort whilst underway. Many of the design decisions made by X-Yachts are to help ensure the yacht not only performs well in all conditions but is also comfortable and enjoyable to sail.

From attentive hull design to ergonomic features throughout the cockpit and interior layout X-Yachts deliver superb comfort at sea on all their boats.

Longitudinal Weight Distribution

Longitudinal weight distribution is hugely important in a sailing yacht as having a lot of weight in the bow and stern will cause pitching and slamming. This is not only very uncomfortable but also puts massive loads through the boat and slows it down.

In order to reduce this slamming to an absolute minimum X-Yachts place all the heaviest equipment such as fuel and water tanks as close to midships as possible.

Moving as much mass as close to the centre of gravity of the boat as possible, reduces the longitudinal moment of inertia,

greatly improving the motion of the boat in waves. With less weight in the bow the boat will slam less.

Keeping weight as low as possible will reduce motions in waves, when motoring and when at anchor for a more comfortable life aboard.

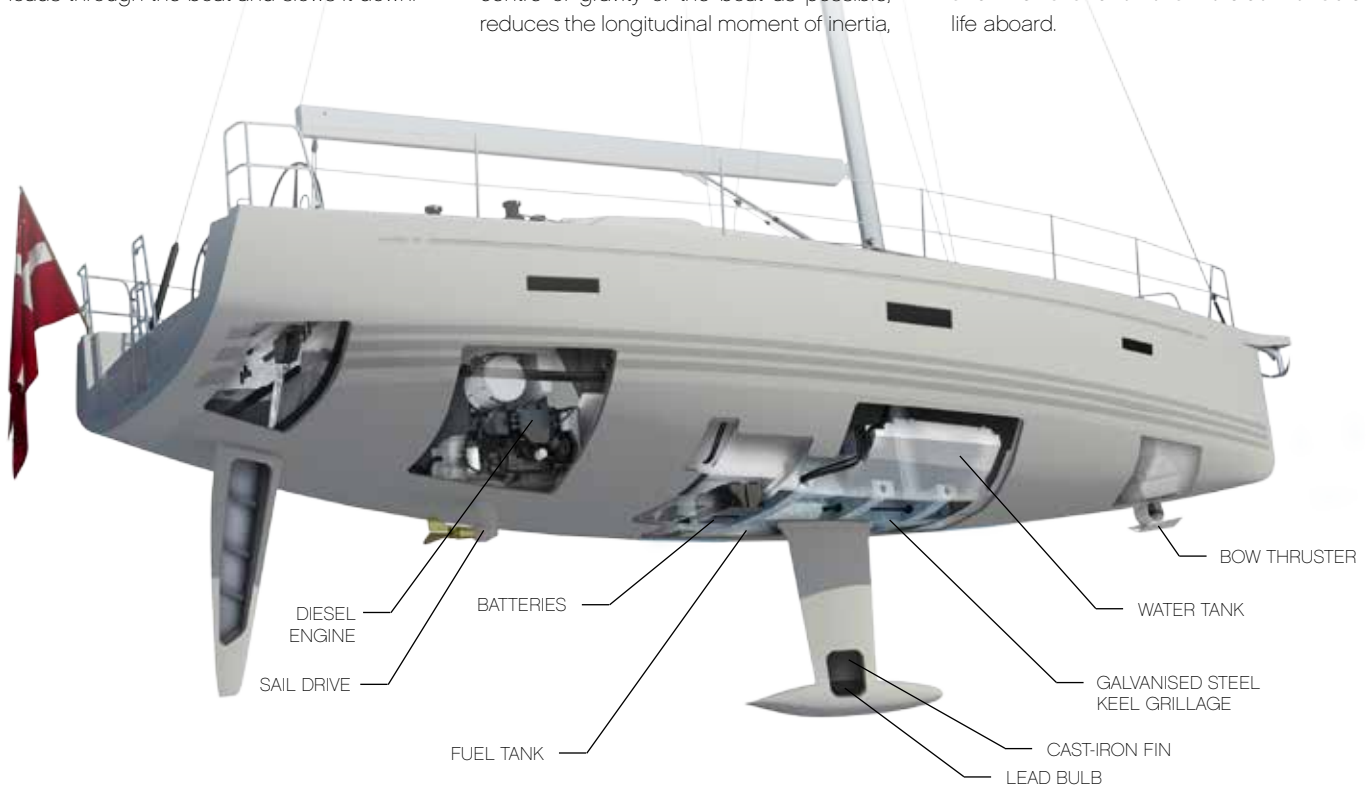

Hull Design

A good sailing yacht is defined by its hull. A well designed hull ensures the yacht can be both comfortable and fast sailing upwind, reaching and down-wind, in light as well as in stronger winds.

Throughout the three ranges X-Yachts' designers take into account the comfort of the yacht's motion in varying conditions and the amount of interior volume to allow for comfortable, luxurious accommodation while not compromising on the performance of the yacht.

X-Yachts is the only internationally reputed boat yard which controls the whole design and production process "in-house". From design in their offices in the UK and Denmark through to their composites factory in Poland and final fit-out at their Yard in Denmark, every stage of a model's design and build is tightly controlled to ensure it fulfils X-Yachts' reputation of fast, comfortable performance yachts.

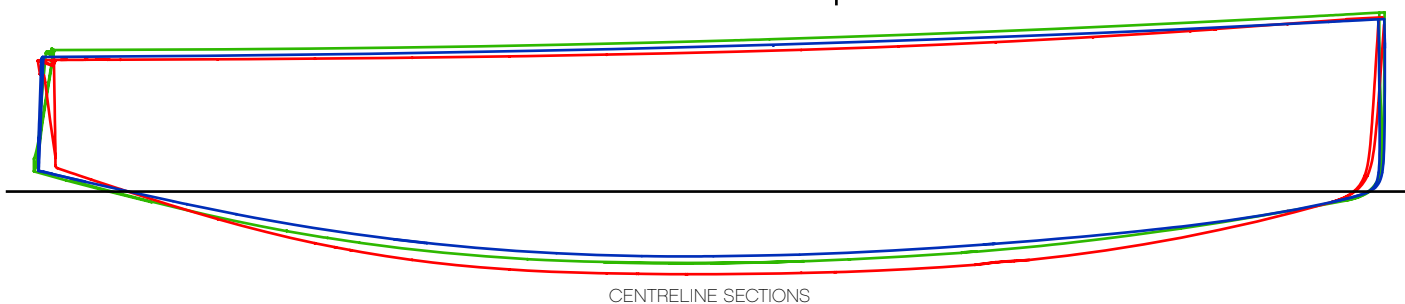
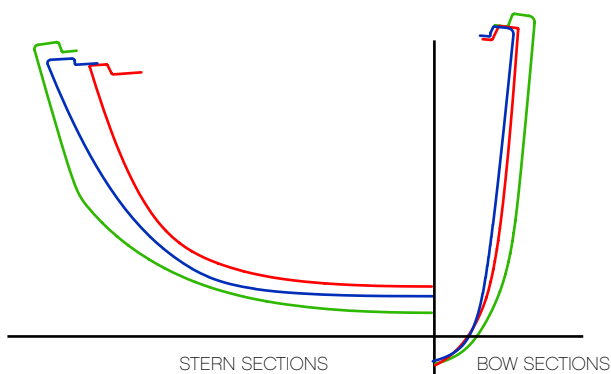

Xp ———

Performance is at the heart of the design for the Xp range. It is important that the yacht is enjoyable to sail, offering exhilarating performance without any compromise.

The increased forward flare on the topsides makes the Xp models easier to drive at full power downwind - whether racing or cruising.

Xc ———

The deeper hull sections, especially around midships, in the Xc range provide a much larger interior volume to allow for larger capacity tanks and other essential cruising equipment.

The deep forward V-sections importantly ensure a smooth and comfortable motion when sailing to windward. The greater displacement allows for a heavier keel to be fitted meaning that the stability is improved.

X ———

The new X range is designed to be the perfect compromise. The slightly higher free-board and more width at the waterline improves the stability of the yacht. The soft chine offers some extra stability upwind.

The rocker line is the "in-between" position of the X range in terms of displacement. The plumb bow is similar to the Xp line and the stern is raked forward and twisted for a more elegant expression.

➔ **MADE IN GERMANY**



FABRICS POWERED BY LIFE, RAIN OR SHINE.

Boat cover fabric, tarpaulin, sprayhood or upholstery fabric – swela offers the right fabric for every purpose.



Previously acrylic, today better:

Thinner, but more tear-resistant high-tech fibres are spun-dyed and woven to a breathable, PVC free, sturdy and durable cloth with a high thread count.



Custom-fit and dimensionally stable:

swela maritime promises a taut fit and a durable, excel stress-strain behaviour, what significantly reduces the risk of sagging.



The marine SFC finish makes the cover repellent to dirt, grease and oil. It is bactericidal, hardly absorbs any water, dries quicker and remains nice for longer.



Ultra Protection Factor (UPF):

Compared with a sun cream this value corresponds to a sun protection factor of 80. This is the best possible UV protection by textile fabrics.

WWW.SWELA.COM

 **swela**
Textile Evolution

Hull Stiffness

The term "stiff hull" is used a lot. But what does this mean? On any yacht the forestay and backstay pull the bow and stern up, whilst the mast pushes down, bending the hull.

If the hull isn't stiff enough it will flex, especially upwind in waves. This can cause the forestay to slacken as the bow hits a wave resulting in sail shape being lost at critical moments. This is known as forestay pumping.

It is easy to make the hull very stiff, the challenge is making it light as well as stiff. X-Yachts have achieved this by using a number of tried and tested methods.

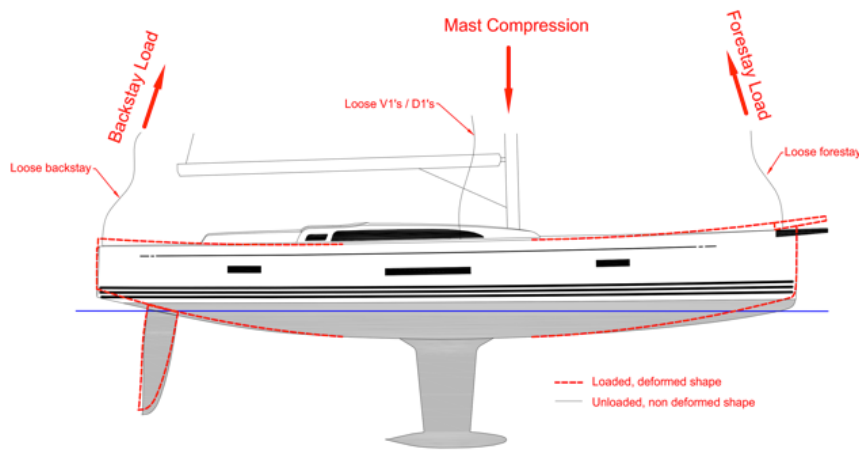

Sandwich Construction

X Yachts use a sandwich construction method. A sandwich panel consists of two single skins separated by a core material.

stiffness without incurring the weight penalty of using solid laminate

Using cored hulls & decks has an additional benefit as it offers insulation to both sound and temperature, enhancing the comfort on-board.

Placing core between the skins is an effective way of increasing the panel

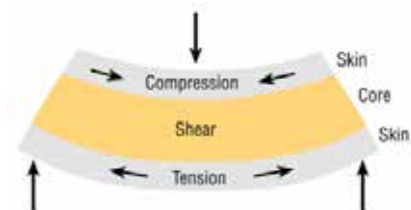

Internal Hull Liners

All X-Yachts are fitted with a structural hull liner. The liner is made in a GRP mould with steel inserts. It is fitted into the yacht while still in its mould to ensure the liner does not flex while being fitted and it therefore stays true to the originally designed shape.

The liner is glued in place then overlaminated to ensure excellent and reliable adhesion. Using a full hull liner can cause problems after the boat has taken damage

such as running aground as it makes it very difficult to inspect the hull and keel structure. X-Yachts have solved this by having large open areas and glueing flanges which allow for inspection of both the bonding of the hull liner as well as the hull itself in the event of a collision or grounding event.

Additionally, including unidirectional fibres in critical areas in the hull and deck can add enormous amounts of stiffness for very little weight gain.

40%

Weight saving in the hull by using sandwich construction over solid laminate.

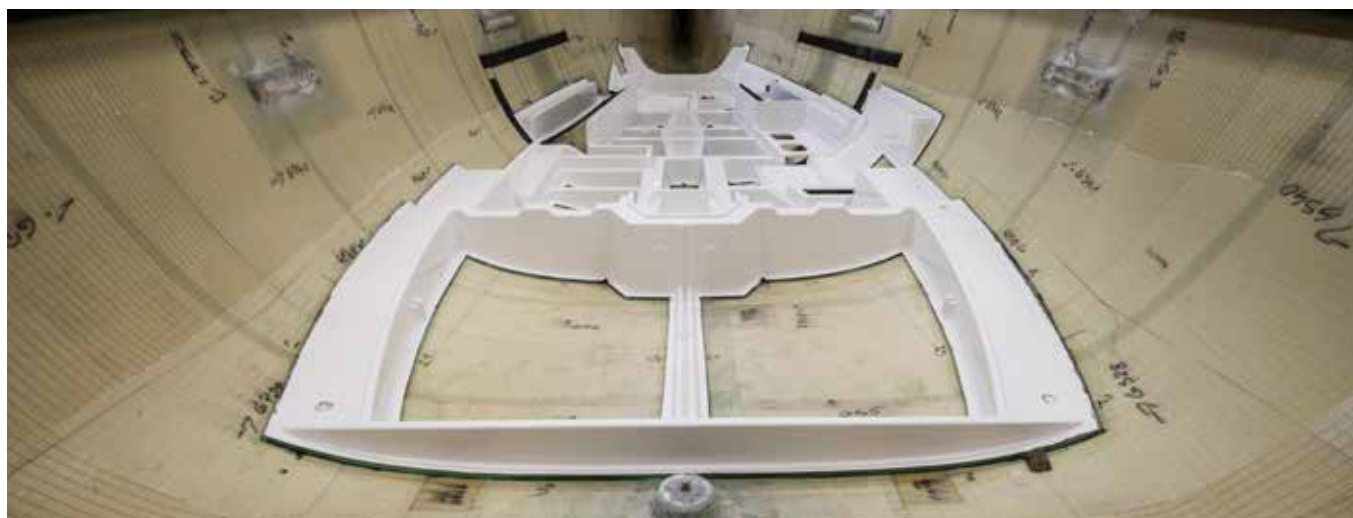



Reduced Drag

The more wetted surface area a yacht has the more drag there is. By reducing resistance and drag in the water we can improve the speed. For that reason X-Yachts optimizes the hull and appendages wherever possible to reduce drag to a minimum.

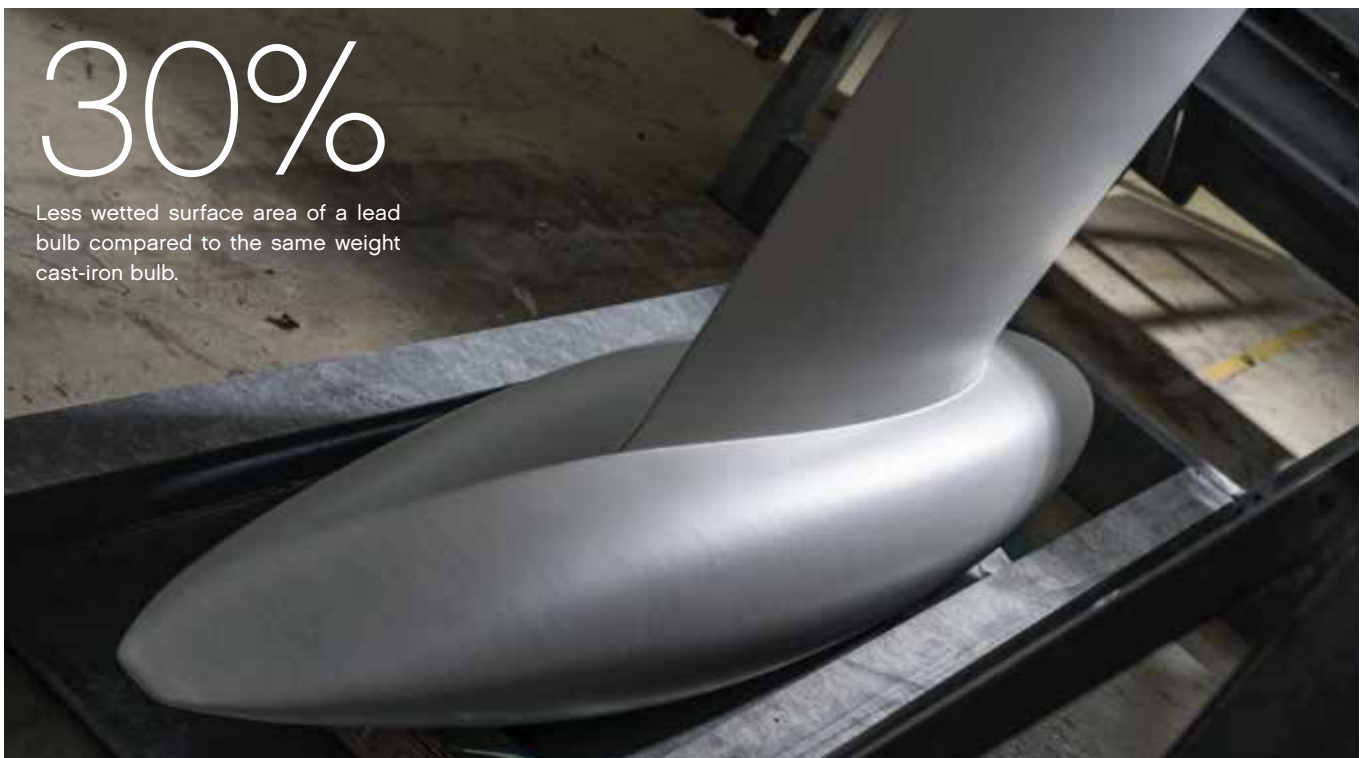

30%

Less wetted surface area of a lead bulb compared to the same weight cast-iron bulb.

Lead Keel Bulbs

X-Yachts use lead keel bulbs. A lead bulb has got a smaller volume than an iron one of the same weight, and therefore a lesser wetted surface area (about 30% saved on the bulb alone).

In both the T and L keels the shapes have been designed to be hydro-dynamically optimised.

Retractable bow and stern thrusters

X-Yachts use a retractable thruster unit when a thruster option is specified, meaning the yacht has a smooth fair hull when it is not in use. Saving significant drag over a tunnel thruster.



Appendages

The keel and rudder represent on average 20% of the wetted surface area of our sailing yachts. Reducing their area would reduce drag, however, it would also reduce the keel and rudders lift which would increase leeway and make it harder to steer.

Instead, X-Yachts ensures they use the optimum profiles for each appendage, and the perfect aspect ratio to offer maximum lift and minimum drag, resulting in better control and higher speed.



Flush Skin Fittings

All through hull fittings on X-Yachts are purposely recessed into the hull and are set back a few millimeters from the hull surface. These are then filled and faired with epoxy filler to ensure a perfect flush finish and minimal drag.

Folding Propeller

A Fixed blade propeller would create huge amounts of drag when sailing. Therefore all X-Yachts are fitted as standard with a 2 or 3-bladed folding propeller.

Encapsulated Keel

All X-Yachts' cast iron and lead keels are encapsulated in a reinforced epoxy e-glass shell to guarantee they have a hydrodynamic and fair finish. This shell also protects the keel from corrosion.

Many of the keels are encapsulated in female moulded GRP shells which guarantee accuracy and ensure the finished keel shape is faithful to the original profile.





Smart boat? More like genius boat!



Give your X-Yacht a boost of intelligence with Raymarine marine electronics. With a legacy of marine innovation spanning over 80 years, we are renowned today for ease-of-use, rugged design, and reliability. We are committed to X-Yacht owners with our industry-leading 3-year warranty and worldwide service network. From a day sail to an offshore adventure - get underway with the confidence of Raymarine on board.

SEE eS SERIES IN ACTION AT WWW.RAYMARINE.COM

Raymarine[®]
BY **FLIR**

Mast & Rigging Specification

Due to the stiff hull of an X-Yacht and the specification of the standing rigging it is possible to have a much higher rig tension and therefore have much greater control over the rig and sail shape.

X-Yachts use rod rigging as opposed to wire rigging. It would be possible to use a smaller diameter of rod rigging for the equivalent strength of wire, however X-Yachts has opted to keep the same diameter as if it were wire rigging meaning the stretch in the rigging is almost eliminated. This also increases the safety margin in the rigging and all the components

A mast section that is too small will not be able to meet the increased rig tension it takes to have full control of the sail plan.

A client may also specify carbon spars which offer greater stiffness for the same weight as an aluminium spar. Carbon spars offer greater control over the sail shape, especially upwind.

To minimize forestay 'sag' for optimum upwind performance, it is essential to be able to tighten the backstay (and thereby the forestay). Many X-Yachts models are fitted with hydraulic backstay adjusters to make it easy to set the backstay tension.

The combination of these elements allows for higher rig tension which reduces movement of the mast and notably increases control over the sail shape. The yacht can then be trimmed to ensure maximum sailing pleasure and boost speed, at the same time increasing comfort and safety.

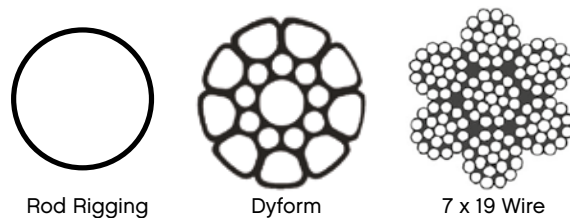

Standard Rigging Differences	% Increases	
	Weight	Surface area / Wind Resistance
Rod Rigging	0%	0%
Dyform	5%	13%
7 x 19 wire	21%	36%

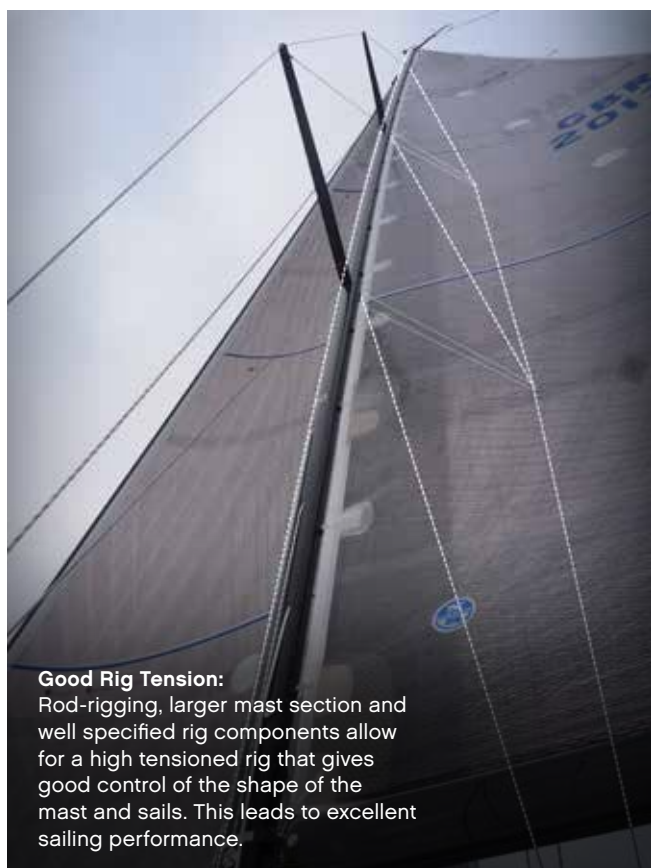

Good Rig Tension:
Rod-rigging, larger mast section and well specified rig components allow for a high tensioned rig that gives good control of the shape of the mast and sails. This leads to excellent sailing performance.



Poor Rig Tension:
Illustrating a yacht without enough tension in the rig. Leeward stays are slack which leads to poor control of the shape of the mast and sails, especially under dynamic loads from waves. Delivers poor sailing performance.

Reduced Rig Weight & Windage

XYachts use rod standing rigging, Dyneema running rigging and a tapered mast section all as standard. This reduces weight and windage up the mast.

Rod rigging has a smaller surface area than Dyform or Wire rigging, for the same diameter. This means that rod rigging generates less wind resistance than either wire or Dyform.

The tapered mast section reduces turbulence coming off of the mast for improved air flow over the sail.

Any weight reduced up the mast has a significantly increases the righting moment as the length of the mast acts as a very large lever, resulting in less heel, more speed and more comfort.



Build Quality

X-Yachts strive to deliver superior quality in every aspect of all of their yachts.

The quality of the build means an X-Yacht will be a pleasure to sail for years to come and is also the reason they such offer exceptionally good re-sale values.

Hand Lay-up and Vacuum Infusion



Vacuum Infusion on Xp and X Ranges

On the Xp and X range where performance is more of an importance X-Yachts have chosen to vacuum infuse the hulls using epoxy resin. This means that you can very precisely control the amount of resin used meaning there is the ideal amount of resin in all areas.

The vacuum infusion process involves the dry fibres being placed into the hull mould, these are then covered with an air tight plastic membrane which has a vacuum

applied to it. Resin is then added through tubes and is 'sucked' through the fibres.

X-Yachts use Gurit Corecell M foam with all infused hulls. Due to the small cell size it minimises resin uptake during the infusion process reducing overall weight. The M-foam core also has superior toughness and impact resistant characteristics. This allows for a reduction of core thickness for the same strength resulting in a lighter hull.

The combination of vacuum infusion, oven baked epoxy and the M foam core is the perfect choice when weight, stiffness and strength are the key factor.

15%

Weight saving in the hull by using vacuum infusion over hand layup.

(Based on a comparison between Xp 38 vs Xc 38)



Photo showing hull liner lamination

“

The hand layup production method has lent itself to seaworthy, ocean going craft for over half a century.

Hand Layup on Xc Range

When weight isn't an overriding factor and robustness is key, there is no better method than X-Yachts' perfected art of hand layup. This process is an excellent way of ensuring a superb quality hull. Each layer of fibre is rolled into the mould one after the other making it easy to inspect at every point.

X-Yachts choose to use saw cut DIAB

core when wet laminating our hulls. With hand layup, the core is easy to inspect because the bond between the core and outer skin can be tested before the inner skin is applied. The process ensures a dependable and repeatable quality product every time.

The thicker outside skins associated with the wet laminated vinylester construction method make for a very tough hull panel.



Rod rigging & Turnbuckles

Rod rigging is fitted as standard to all X-Yachts & has been upgraded to a larger diameter. X-Yachts uses racing turnbuckles which are much easier to adjust than the traditional type and look sleek & stylish

Teak Decks

All our teak is hand selected from a sustainable source. On the decks, coach roof and cockpit sole we use 9mm, kiln dried, quarter sawn teak which results in a more stable and even deck. It is sealed with black, white or grey caulking, which lasts for many years without becoming hard and brittle.

Whilst most yacht builders join their teak planks with caulked seams, X-Yachts uses glued finger joints. This creates a beautiful seamless look along the deck.



Craftsmanship

Our team of experienced and skilled carpenters carries out the interior joinery on all X-Yachts. While the styling may be contemporary, the joinery skills employed in constructing the yachts have been handed down through the generations. The boats are durable and easy to live on because the team use high quality materials and work to an agreed set of measurements chosen for their ergonomic advantages.



Above: X-Yachts use wood responsibly sourced and produced through all stages of the manufacturing process, from direct forest management to final finishing by X-Yachts. It conforms to Forest Steward Council (FSC) certification – the strictest international standard for wood production.



Above: One of the forms used to create the wooden fiddles on the Xp range. Thin layers of wood are laid into the mould and glued together while under compression from the mould.



Left: Final edge details being added to a teak shower tray used on many of X-Yachts models.



SPINEX

Top down spinnaker furler

*(RE)discover the joy of your
asymmetrical spinnaker*

4 models available:

for boats from 5 to 18 m

SPINEX 0.9

SPINEX 1.5

SPINEX 2.5

SPINEX 5.0

Download the
Spinex video



profurl.com



High Capacity Battery Banks

Battery banks are sized to last longer than required and provide longer autonomous range. X-Yachts uses AGM batteries for improved reliability, faster charging and they are less prone to sulfation. Lithium-ion batteries are also available as an upgrade on most yachts.

Engineering Installations

X Yachts are designed for extensive sailing, whether blue water cruising or regatta racing you need to be sure that all the systems on board are reliable.

Our team of engineers, with over 30 years experience, fit all the systems from engines, generators, and air conditioning systems in house ensuring it is all fitted and installed to the highest standards.



Central Lift Point

X Yachts are designed to be lifted using a single lift point that is integrated in the keel structure. This is ideal as it means there is no risk of damaging propellers and rudders as well as not scratching the hull with lifting straps. It also proves just how strong and well balanced the yachts are.

Next Generation Cruising

Welcomed with open arms, the Xc range has been successfully taken into the next generation

Over the past 2 years, the world renowned Xcruising line was taken into the Next Generation. After one million cruising miles and feedback from numerous owners, we went back to the design board to modify some of the features to bring even more comfort and light into cruising. These included larger bathing platforms and hull portlights.

Today the Xcruising line encompasses five models - Xc 35, Xc 38, Xc 42, Xc 45 and Xc 50 and are all based on the same principles - a moderate hull shape with increased displacement, allowing for larger engines, batteries, tanks and anchoring gear. They share deep sections, and a forward 'V' shape to minimise slamming and make for a comfortable motion when going through waves, either under power or sail.

Designed for long-distance passages, the Xcruising line features extensive teak decking, and a wide choice of windscreen, sprayhood and bimini options.





Xcruising features

- Moderate draft for remote anchorages (extra-low draft available)
- Folding transom to form a swim platform (motorised on larger models)
- High cockpit backrest for excellent protection, with options including windscreen, sprayhood and bimini
- Optional 'A' frames for asymmetric sails, discontinuous rod rigging, through-deck mast with tapered section
- Teak cockpit and swim platforms as standard on Xc 38, 42, 45 and Xc 50
- Generous diesel engine in well-insulated compartment

Xc qualities

The Xcruising range leads the market with the highest quality deck fittings and choice of comfort features.

For the Xcruising range, X-Yachts created a new collection of hull forms with increased interior volume and deeper hull sections, which allow for generous accommodation but also offer high stability, sparkling sailing performance and a smooth motion in choppy conditions.

The strong steel keel frame structure provides unbeatable resistance to grounding.

Sail handling is designed to be stress-free whether short-handed, single-handed, or sailing with a full complement of friends and family.

The Xc 38, 42, 45 and 50 have the option for

an additional inner forestay to set a smaller, balanced sailplan in stronger breezes.

Single line mainsail reefing is fitted as standard, with the option for in-boom furling.

Besides a furling genoa the Xc yachts also offer an anchor A-frame which allows modern furling cruising spinnakers to be set, or asymmetric sails with a simple snuffer device for dousing.

Large tank volumes, a folding propeller and powerful engine in a soundproofed compartment add to the enjoyment of life at sea.







Xc 35

Perfectly Formed

The smallest member of the Xc range, the Xc 35 is a compact cruiser with a big heart.

The smallest member of the highly acclaimed Xc family, the Xc 35 has won a number of awards over the past six months including Sail Magazine's "Boat of the Year 2015".

She follows the Xc DNA by having a fuller hull, a more spacious, commodious interior and an easier motion, without compromising any cruising comfort and sailing performance.

She is a compact but surprisingly well-equipped bluewater cruising

yacht with smooth hull lines, a stylish yet practical cockpit and uncluttered but functional deck layout "a fun ride for cruisers who care about performance" (SAIL Magazine, 2015).

Easily sailed short handed, she can also accommodate guests with a two double cabin layout, spacious saloon and ample storage.

She comes with a choice of keel drafts and options.



Interior Perfection

The Xc 35 is offered in a spacious two-cabin layout, with two generous double berths and a comfortable heads with shower as standard. Ventilation and natural light are maximised throughout thanks to open aluminium-framed portlights with a stylish chrome finish, and frameless flush-mounted deck skylights.

The traditionally styled and highly practical interior is crafted from hand-selected technical teak, and varnished with a satin finish. High quality materials are used

throughout, including Corian worktops in the L-shaped galley, toughened glass splashback, and comfortable cushions and mattresses.

Additional cruising features include teak on the cockpit and bathing platform, with the option to extend it across the deck. The large transom door incorporates an integrated hinged stainless steel bathing ladder and conceals the six-person liferaft storage compartment, designed for easy deployment.

There are generous cockpit lockers aft and to starboard, and a large self-draining locker to accommodate multiple gas bottles. An optional stainless steel A-frame conceals and protects the anchor, as well as providing a tack point position from which to fly downwind asymmetric spinnakers. The foredeck conceals a watertight anchor locker, where an optional electrical windlass may be fitted.

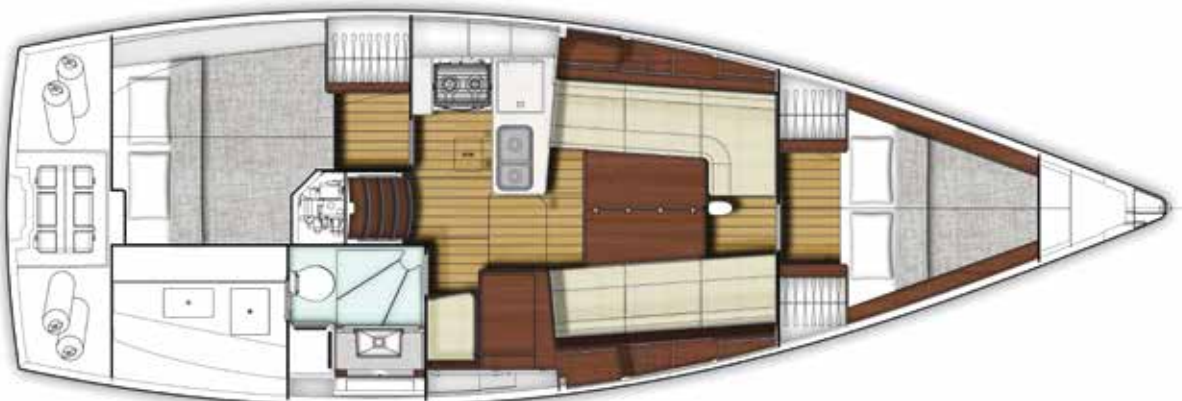



Superior Structure

The Xc 35 has a sandwich construction hull and deck with X-Yacht's famous steel keel girder system for unrivalled rigidity and security.

It carries a deep keel for a low centre of gravity, with an optional shallow draft version, recessed through-hull fittings and a folding propeller for reduced drag.

Above deck, there is a keel-stepped tapered

mast section, with discontinuous rod rigging as standard, and powerful backstay adjustment for complete control.

A furling headstay as standard makes for stress-free short-handed sailing, with twin wheels, six large self-tailing winches and an under-deck mainsheet system led aft from the coachroof.



Xc 35 Dimensions

LOA (including anchor roller)	10.94 m	35 ft
Hull length	10.36 m	34 ft
LWL	9.60 m	31.6 ft
Beam	3.52 m	11.5 ft
Standard draft	1.90 m	6.2 ft
Alternative draft	1.60 m	5.2 ft
Ballast (standard)	2,150 kg	4,739 lbs
Displacement (light)	6,450 kg	14,219 lbs

ENGINE/TANKS

Engine diesel	22.5 kW	30 HP
Fuel tank	165 Ltr	44 Gal (US)
Water tank	245 Ltr	65 Gal (US)

SAIL AREAS

Mainsail	35.75 m ²	384.8 ft ²
Genoa (106%)	29.65 m ²	319.15 ft ²
Genoa (135%)	37.75 m ²	406.34 ft ²
Spinnaker (asymmetric)	101.14 m ²	1,089 ft ²



Xc 38

Double the Fun

The perfect package for doublehanded sailing.

The Xc 38 was the second yacht in the Xcruising range to be named European Yacht of the Year in the Luxury Cruiser category, the judges being particularly impressed by the spaciousness and luxurious levels of comfort in the interior.

Under sail, motor or in harbour, the Xc 38 may be easily and safely sailed double-handed, yet still offers ample space both above and below deck to accommodate guests and family.

Fastest In-boom mainsail system



In-boom mainsail furling system for luxury boats like the X-Yachts and many others...

With the FurlerBoom in-boom mainsail system, you can enjoy a fully battened mainsail with roach.

No compromise in stability and performance.

FurlerBoom has been fitted on all +35 foot X-Yachts, ask us to quote yours on www.FurlerBoom.dk.

FURLERBOOM



Dual Luxury

The Xc 38 sets new standards in its class for both the spaciousness of the interior and high quality of finish.

A two-cabin layout creates a roomy feel throughout, with comfortable double cabins and a large saloon.

There is a large and luxurious heads with separate shower.

Opposite a well-equipped U-shaped galley, there is a dedicated forward-facing navigation station, with specifically designed storage aft for bulky items.

High quality, detailed interior carpentry sets the Xc 38 apart from mass produced boats.

Marine plywood with carefully selected surface veneers, laminated fiddles and

door frames, all varnished and polished in satin matte finish.

The laminated floorboards are standard teak with holly stripes.

The model comes in a variety of standard and optional upholstery fabrics.





Why spend time looking for a shore power connection?

Enjoy power as you do at home with your Fischer Panda generator - wherever you are

Fischer Panda offers a wide range of marine generators from 3.8 kW to larger units of up to 170 kW to suit your individual energy requirements.

All Fischer Panda generators are built to be:



compact



light



quiet



Fischer Panda GmbH
33104 Paderborn, Germany
www.FischerPanda.de
Tel.: +49 (0) 52 54 / 9202-0
info@fischerpanda.de



Fischer Panda[®]

Power
wherever
you are[™]



Zeus³



Designed for sailors, built for sailing

The **NEW** Zeus³ is a complete chartplotter navigation system for blue water cruisers and regatta racers. The ultra-bright, wide-angle SolarMax HD IPS display combines all-weather touchscreen technology with rotary dial and keypad controls.

Easy to use dedicated, race-proven sailing features including SailSteer, Laylines, and RacePanel. Connect with online services and mobile devices using built-in Wi-Fi, and integrate seamlessly with a wide range of instruments and accessories for greater safety, performance, and enjoyment on the water.

 SAILING FEATURES

 10 HZ GPS

 NMEA 2000[®]

 WIRELESS

 IPX7 WATERPROOF

 2 YEAR WARRANTY

SIZES AVAILABLE



B&G
OFFICIAL SUPPLIER



www.bandg.com

B&G

A Passion for Sailing



Clean lines

The Xc 38 offers a clean, uncluttered deck layout thanks to under-deck halyards, with all lines led back to the coachroof.

Deck hatches are flush mounted, the anchor is concealed within its own recessed foredeck locker, and stylish teak surfaces are fitted as standard.

A German-style mainsheet is within easy reach

of the helmsman for rapid responsiveness and complete control.

The maintrack is also moved out of the cockpit to give a clear route from stern to companionway.

Furling genoas and self-tacking jibs make for stress-free headsail handling, plus the option of davits to ease launching the tender.

Xc 38 Dimensions

LOA (including anchor roller)	12.2 m	40 ft
Hull length	11.58 m	38 ft
LWL	10.38 m	34.06 ft
Beam MAX	3.81 m	12.50 ft
Draft (standard)	1.98 m	6.50 ft
Draft (shallow)	1.60 m	5.20 ft
Ballast (standard keel)	3,775 kg	8,320 lb
Displacement (light)	8,700 kg	19,180 lb

ENGINE/TANKS

Engine diesel	30 kW	40 HP
Water tank (standard)	375 Ltr	99 (US) Gal
Fuel tank (standard)	200 Ltr	53 (US) Gal

SAIL AREAS standard

Mainsail	44.1 m ²	660 ft ²
Genoa 140%	47.8 m ²	514.5 ft ²
Genoa 106%	36.2 m ²	390 ft ²
Self-tacking jib 94%	32.1 m ²	346 ft ²
Spinnaker (asymmetric)	131 m ²	1,410 ft ²





X^C 42

Cruising Freedom

The Xc 42 offers multiple options to suit your every need.

The Xc 42 offers multiple options including an adaptable sail plan that ensures superb pace on all angles, with options including an inner forestay (without runners).

She may fly either a 140% overlapping genoa or smaller 108% genoa, 90% self-tacking jib, or asymmetric spinnaker, for relaxing sailing on long

bluewater passages and short stopovers, sailing with two crew or a full complement of guests. Sail area may be easily adjusted thanks to a furling forestay and slab-reefing mainsail, or optional in-boom furling.

Anchoring and mooring are also stress-free, thanks to a bow thruster, electric windlass, large bow locker, and optional stern davits for a tender.



Generous space

The Xc 42 is offered in two spacious three-cabin layouts, with either a forward-facing or central navigation station, and either a compact WC or extra generous wetroom-style heads, both accessible from the main saloon.

New interior styling points include full LED lighting, both above and below decks. Thanks to new larger hull portlights there is also increased natural light in the saloon and cabins. The galley features new fixtures and fittings, including automatic soft-close drawers, and space for appliances such as a microwave and Nespresso machine.





Freedom

with Victron Energy on board



Inverter/chargers,
batteries and more

Energy. Anytime. Anywhere.



victron energy
BLUE POWER

www.victronenergy.com

Energy. Anytime. Anywhere.



Multiple Choice

The exterior of the Xc 42 also benefits from some updates, including optional teak on the side decks and coachroofs, as well as new hull and canvas colour choices.

The bathing platform has increased in size, and the standard wheels now incorporate 'crashbars' with an option for integrating the throttle and bow-thruster controls.

Xc 42 Dimensions

LOA (including anchor roller)	13.44 m	44 ft
Hull length	12.81 m	42.03 ft
LWL	11.37 m	37.30 ft
Beam MAX	4.10 m	13.45 ft
Draft (standard)	2.10 m	6.90 ft
Ballast	5,160 kg	11,376 lb
Displacement (light)	11,400 kg	25,133 lb

ENGINE/TANKS

Engine diesel	40 kW	55 HP
Water tank (standard)	520 Ltr	137 Gal
Fuel tank (standard)	250 Ltr	66 Gal

SAIL AREAS standard

Mainsail	53 m ²	570 ft ²
Genoa 108%	43.5 m ²	468 ft ²
Genoa 140%	56.6 m ²	609 ft ²
Self-tacking jib 94%	36.1 m ²	389 ft ²
Spinnaker (asymmetric)	158.2 m ²	1,703 ft ²





Xc 45

Pure Cruising

The Xc 45 was the first to be launched in the Xc Range and remains a firm favourite for many.

The Xc 45 was the first model in the Xcruising range to be launched, and was named European Yacht of the Year, praised for her combination of cruising comfort, performance under sail and responsive handling.

As with all the Xc models which followed, the Xc 45 incorporates the X-Yachts steel hull/keel girder for strength and resistance to

grounding, with deck and sail layouts designed for ease of handling when sailing two-up.

Like the rest of the range, she has been taken into the "Next Generation" meaning more spacious bathing platforms, enlarged hull portlights, improved storage and functionality in the interior, and updated styling options.

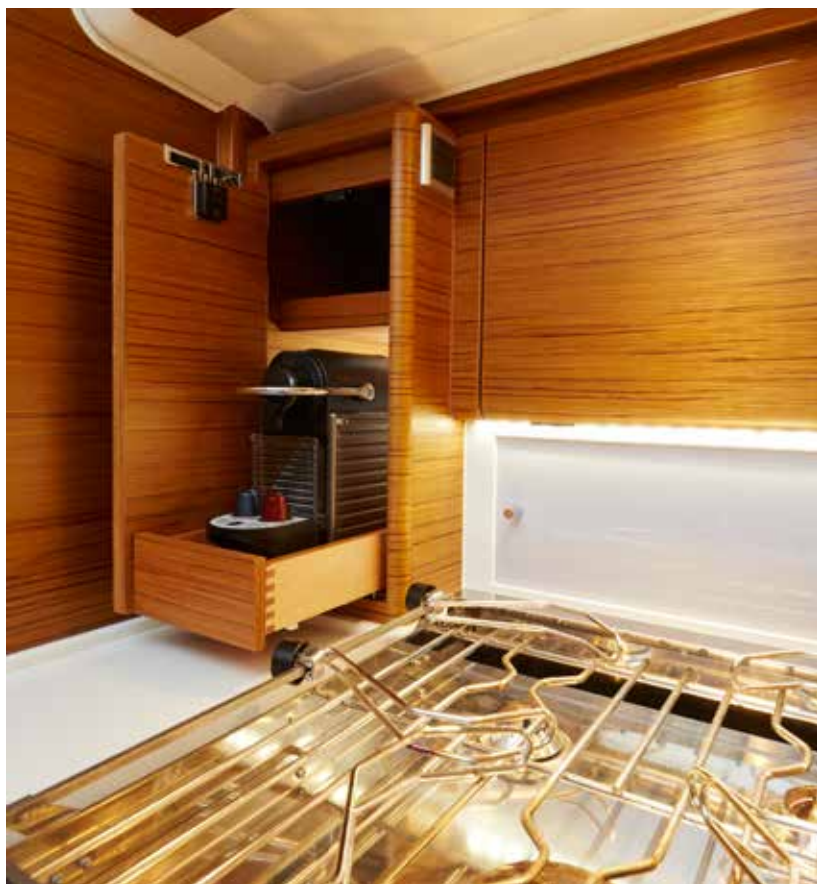

Interior quality

The high quality galley comes with space for optional appliances such as a Nespresso machine, microwave and top-loading deep freezer, automatic soft-closure drawers, and specially designed refuse storage. Corian worktops and a toughened glass splashback are fitted as standard.

The saloon features a large table, luxurious cushions for improved comfort, and integral bookcases for storage. There is a choice of interior finishes, including black or white Corian worktops and fabric or microfibre upholstery in modern colour ways, with teak and holly striped floorboards as standard.

The Xc 45 has a flexible interior with three double cabins and two heads. There is a choice of standard forward-facing full-sized nav station, with a WC accessible from the saloon, or a more compact chart table and spacious heads with separate shower stall.

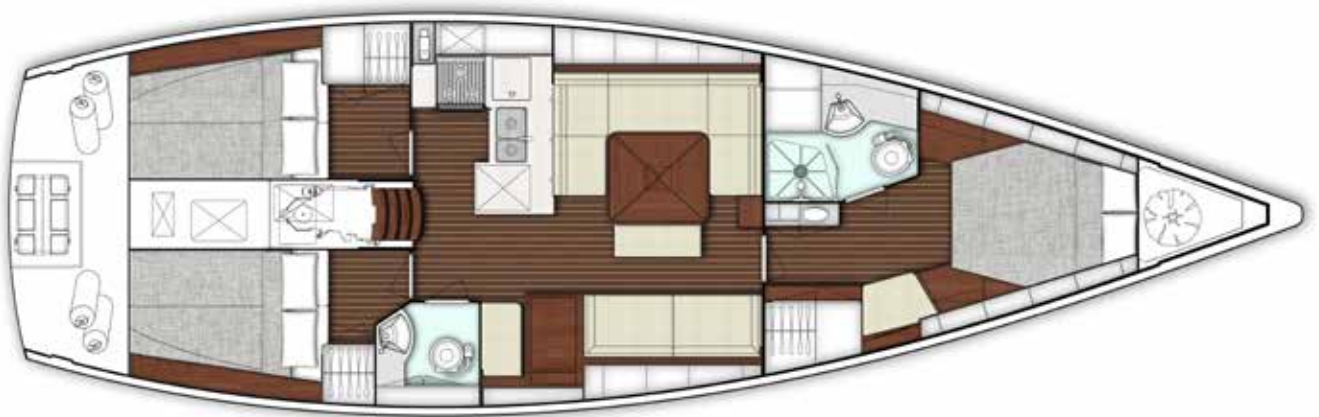



Racing or Cruising

Ronstan provides innovative and practical gear to improve your performance or make your sailing easier, more enjoyable and safer.



E1 ELECTRIC WINCHES

Experience empowerment

At the push of a button easily hoist and trim sails of any size. E1 Electric Winches remove the requirement for physical strength, making it possible for any crew member to easily and safely control lines and sails. E1 Electric Winches are engineered with unsurpassed levels of functionality, monitoring and protection, and feature Andersen's award winning stainless steel drum design with Power Rib™ line control for secure, positive grip.



BATTEN SYSTEMS

Quick, easy and reliable

The patented Ronstan Ballslide™ system uses the existing luff groove of your mast, so that no track needs to be installed. Ballslide™ cars have captive ball bearings for free-running performance, that can simply be removed from the mast with the mainsail. The range includes all elements for a complete system, including cars, headboard plates and batten receptacles.



CONTINUOUS LINE FURLERS

Refined design and performance

For straight luff screechers and code sails, or in top-down version for asymmetric spinnakers and gennakers, Ronstan continuous line furlers deliver the speed and enjoyment of off-the-wind sails deployed and retrieved instantly from the safety of your cockpit.

CORE BLOCKS

The ultimate combination

The ultimate combination of performance, reliability, low maintenance and long service life. A true all round solution and the ideal choice for sheets, halyards and control line applications for cruising and racing. Available in three range sizes to suit your needs - 45mm, 60mm and 75mm.



www.ronstan.com



STAINLESS STEEL WINCHES

www.andersenwinches.com

Sail Plan

The standard rig package includes an aluminium mast with discontinuous rod rigging and hydraulic backstay for efficient and repeatable tuning.

X-Yachts work in collaboration with top sail lofts to develop a range of sails that work perfectly with the rig.

Xc 45 Dimensions

LOA (including anchor roller)	14.5 m	47 ft
Hull length	13.86 m	45.47 ft
LWL	12.76 m	41.80 ft
Beam MAX	4.32 m	14.17 ft
Draft (standard)	2.20 m	7.21 ft
Ballast	5,965 kg	13,150 lb
Displacement (light)	13,220 kg	29,145 lb

ENGINE/TANKS

Engine diesel	55 kW	75 HP
Water tank (standard)	615 Ltr	162 Gal
Fuel tank (standard)	440 Ltr	116 Gal

SAIL AREAS standard

Mainsail	61.3 m ²	660 ft ²
Genoa 108%	50.7 m ²	545 ft ²
Genoa 140%	65.3 m ²	702 ft ²
Self-tacking jib 94%	44.1 m ²	475 ft ²
Spinnaker (asymmetric)	180 m ²	1,938 ft ²





Xc 50

Ocean Style

The largest Xc model, the Xc 50, is a refined bluewater cruising yacht.

The Xc 50 is the largest model in the Xcruising range and offers a wide range of custom options to allow owners to create an elegant personalised yacht.

Design details include minimalist flush opening deck hatches, smart interior recessed teak stripes, stylish lighting, and a choice of bimini and sprayhood options.

The innovative Xcruising folding transom includes additional features on the Xc 50. Besides a hinged liferaft storage compartment to starboard, there is also an extra storage compartment to port for a stern anchor, or flammable materials such as diesel cans. The centre of the transom hydraulically folds down to form a bathing platform, with optional davits for a tender. →



Top notch

Custom options include an extra large owner's cabin with ensuite heads to port, incorporating space for appliances such as a washing machine. Alternatively the Xc 50 can accommodate a forepeak crew cabin, and central master heads. Aft there are two roomy double cabins, with the option of both ensuite. Alternatively an extra spacious galley can be created with

additional worktop space to port, and a single aft heads with shower. The galley features space for two refrigerators, optional microwave, and a Nespresso machine.

Interior finish choices may also be customised, with a choice of contemporary and traditional materials, to complement the hand-finished furniture made by X-Yachts' own craftsman joiners.





Easily managed

Underway, the high stability Xc 50 is generously canvassed, but with a high specification deck layout and controllable rig, it has been designed to be easily manageable, resulting in unmatched sailing performance.

The Xc 50 will reach maximum hull speed in approximately 9 knots of true wind speed, using the 140% overlapping genoa.

The sail plan has been created

specifically for long distance cruising, and includes a 106% non-overlapping genoa, and 94% self-tacking jib.

The mainsail comes with slab-reefing as standard, or there is an option of in-boom furling.

The Xc 50 is also easily sailed short-handed, with under-deck halyards led aft to self-tailing winches (including electric options) and a secure central console.



Xc 50 Dimensions

LOA (including anchor roller)	15.61 m	51 ft
Hull length	14.99 m	49.18 ft
LWL	13.51 m	44.32 ft
Beam MAX	4.6 m	15.09 ft
Draft (standard)	2.35 m	7.71 ft
Draft (shallow)	1.95 m	6.40 ft
Ballast (standard keel)	7220 kg	15,913 lb
Displacement light	16,085 kg	35,460 lb

ENGINE/TANKS

Engine diesel	809 kW	110 HP
Water tank standard	808 Ltr	213 (US)
Gal		
Fuel tank standard	614 Ltr	162 (US)
Gal		

SAIL AREAS standard

Mainsail	70.9 m ²	763 ft ²
Genoa 106%	56.7 m ²	610 ft ²
Self Tacking Jib 94%	50.3 m ²	541 ft ²
Asymmetric spinnaker	202 m ²	2,174 ft ²

New performers

X-Yachts launches the 2018 edition of the Award winning Xperformance range.

Combining almost a 40-year heritage of creating performance yachts with the very latest in contemporary yacht design and build technology, the Xp range is the fourth generation of performance yachts by X-Yachts.

The Xp range consists of the Xp 33, Xp 38, Xp 44, Xp 50 and Xp 55.

Based on experience and feedback, X-Yachts have optimized the Xp's to match the latest demands, giving birth to the new 2018 edition of Xperformance.



Xp innovation

The Xp yachts may be highly customised with many exclusive features



Stability is key, with each yacht designed to carry an increased proportion of its weight in the deep bulb.

A significantly improved ballast to weight ratio, thanks to a hi-tech epoxy vacuum infusion build process with localised use of carbon, also contributes to an enjoyable and responsive sailing experience.

The Xp range is designed to be truly dual-purpose, and each model is offered with both standard aluminium and optional high aspect carbon rigs.

All Xp models come standard with T-keels and are offered with special shallow or deep keel options.

Asymmetric headsails and under-deck

furlers ensure owners can switch simply between short-handed and fully crewed sailing modes.

The Xp 38, Xp 44, Xp 50 and Xp 55 feature a choice of four multifunctional bowsprit options for flying asymmetric sails and easy anchoring, while the Xp 33 has a modern retracting bowsprit, and every Xp may also carry a symmetric spinnaker pole.



Xp 50 sailing in Palma Bay.



Xp 38's side by side with different bow options



Standard GRP cowl with integrated anchor fitting



Optional carbon bowsprit without anchor



Optional white painted carbon bowsprit with integrated anchor fitting

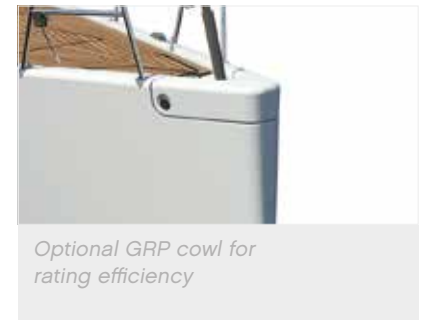

Optional GRP cowl for rating efficiency

Xperformance features

- Vacuum infused epoxy hull construction
- High stability and large sail plan
- Composite, encapsulated lead T-keels with draft options, recessed hull fittings
- Discontinuous rod rigging as standard
- Carbon keel frame structure for strength, safety and reliability
- Various exterior and interior finish options

spinlock

DECKVEST 5D

HIGH SPECIFICATION OFFSHORE LIFEJACKET HARNESS

- // 170N or 275N buoyancy with deck safety harness
- // Sprayhood fitted to prevent secondary drowning
- // Pylon™ 360° lifejacket light included
- // Lume-On™ bladder illumination lights included



DECKVEST LITE

ULTRA LIGHTWEIGHT LIFEJACKET

- // 170N buoyancy
- // Ultra lightweight, low profile design
- // Perfect for inshore sailing, RIBs and powerboating
- // Easily converts to 'manual only' firing
- // Optional Pylon™, Lume-On™ and Sprayhood



DECKVEST CENTO

Junior automatic lifejacket harness

- // 100N buoyancy with deck safety harness
- // Suitable for juniors weighing 20-50kg
- // Optional Pylon™, Lume-On™ and Sprayhood



www.spinlock.co.uk



The optional cockpit table is stored below the cockpit floor hatch.



The Xp 50 and Xp 55 feature a large bathing platform and dinghy garage as standard.

On deck

The optional cockpit table folds neatly away into its own recess in the cockpit sole, enabling a swift change from functional sailing area to stylish entertaining zone.

On the Xp 50 and 55 an electrically operated folding transom creates a secure stern area when underway or can be deployed to form a teak-topped bathing platform with transom hung stainless steel swim ladder. The transom garage offers a roomy storage area which can accommodate most tender dinghies up to 2.7 - 3 m in length with ease.

On the Xp 38 and Xp 44 an optional bathing platform can be ordered.

The four larger models offer a choice of three pedestal options to customise the twin composite wheels and ensure every skipper has their preferred information at their fingertips.



New - Standard pedestal in black grey RAL7021 gelcoat finish.



Optional compass mount with grab-rail.



New - Optional instrument mount in same colour as pedestal to accommodate 9" plotter and additional controls.

The Science of Seamless

Hall Masts Engineered to Perform



Hall engineers start with Finite Element Analysis, creating laminates with precise bend characteristics. Hall's ability to apply stiffening at any location on the mast elevates optimal tuning and performance.

Hall ensures structural integrity and consistent aerodynamics through the application of 90-degree layers of carbon. These layers wrap continuously around the circumference of the mast.

Continuous "off-axis" layers are applied in alternating directions. These layers control twist and add compression and bending strength.

Each layer is carefully compacted prior to curing in the autoclave. This ensures a smooth, wrinkle-free, virtually void-free laminate.

No filler, no screws. A Hall mast presents a beautifully smooth and consistent surface.

All structural carbon is unidirectional, pre-preg carbon. Hall's application of unidirectional carbon fiber under tension turns our complex strength and bending performance predictions into reality.

www.hallspars.com

We invite you to visit one of our three factories to experience the Hall Seamless process firsthand:

Europe Deltahoek 42 - 4511 PA Breskens, Holland +31 117 381397 infobv@hallspars.com

USA 33 Broadcommon Road - Bristol, RI 02809 +1 401 253 4858 info@hallspars.com

Pacific Rim 100 Foundry Road - Silverdale 0932 - Auckland, New Zealand +64 9 4275472 infonz@hallspars.com

Structural Integrity

Every element of an X-Yacht bears the hallmark of quality. Each detail of our yachts is designed in-house to give the sailor a truly superior sailing experience.

The Xp range includes our newest and most cutting-edge technological advances. Strength, stiffness and a high ballast to weight ratio are key to creating yachts which offer superb sailing pleasure and performance.

The Xp's are built using epoxy infusion with

carbon reinforcements in both the hull and the hull liner. Vacuum infusion allows for very precise control of overall weight and material ratios. The liner is glued and bonded to the hull before the hull leaves the mould for precision.

Building on the unrivalled reputation of X-Yachts' trademark steel frame structure, the new Xp designs feature a carbon/composite keel grillage.

Reinforcement in the chainplate area utilises a combination of uni-directional

and multi-axial fibres to effectively transmit the loads into the hull shell.

The structural wardrobes are designed as part of the yacht's internal building blocks, thus saving weight on duplicated structures.

The weight saved throughout the construction of the Xp's is put back into the deep lead T-bulb keel, for a maximized ballast to weight ratio.

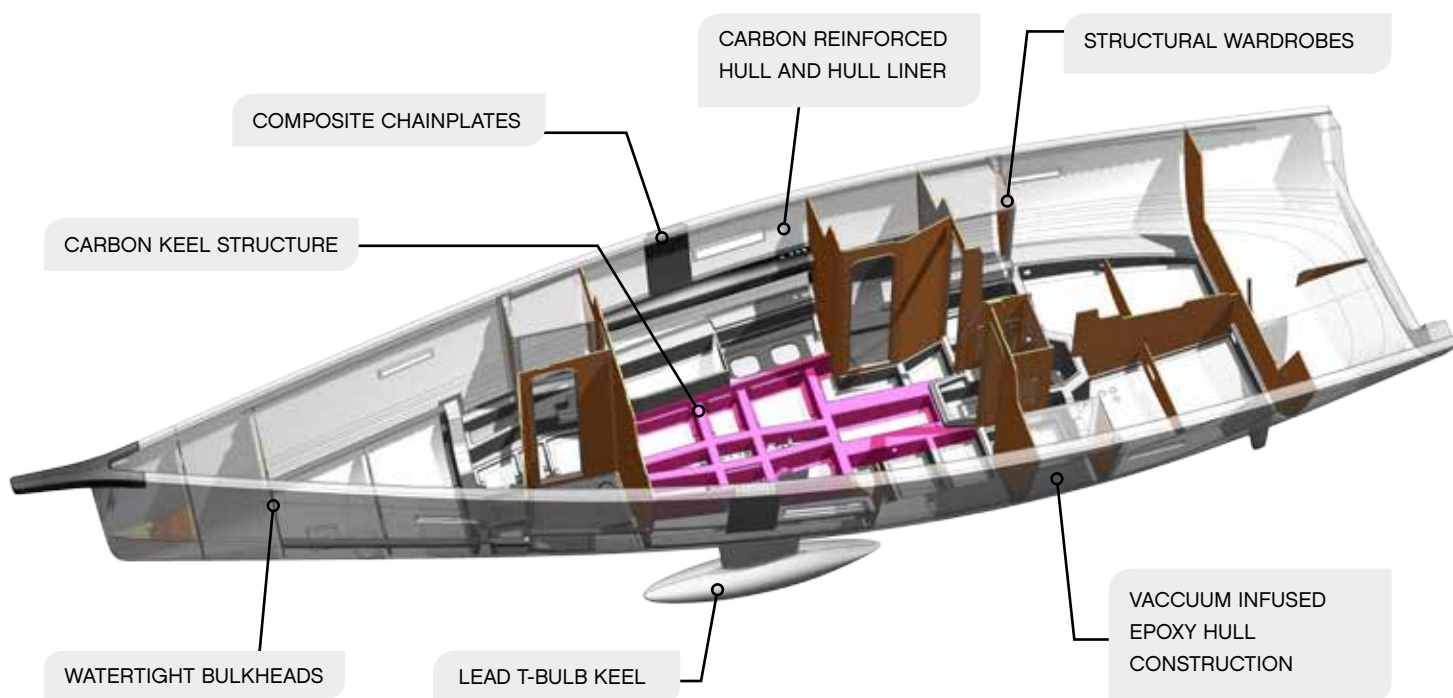

Structural layout of the Xp 44.

Interior Style

The Xp interior design philosophy is to offer stylish, contemporary, and practical living spaces.

New materials and methods combined with over 35 years design and production experience result in functional, practical and welcoming interior space.

The galley is designed to accommodate favourite modern appliances, such as a coffee machines and microwaves, as well as high-quality essential fittings including a gimballed gas oven and easily accessible toploding fridge-freezers, or optional differing sizes front opening fridges.



Xp 44 teak interior shown here. A range of interior finishes is available.

New Xp Edition

This year will see the launch of the 2nd generation of all Xp's models

This revamp aims at making the Xp models attractive for all sailors and not only the racier of us. Improved performance will make the yachts more comfortable for cruising whilst keeping all their racing capabilities. The yachts exterior styling and functionality is reviewed for marrying with the latest trends and the larger models Xp 50 and Xp 55, will appear with greatly modernised and improved interiors.

The yachts technical specifications will all get an overhaul and mirror our latest knowledge from the introduction of the latest X4³ and X6⁵ models.

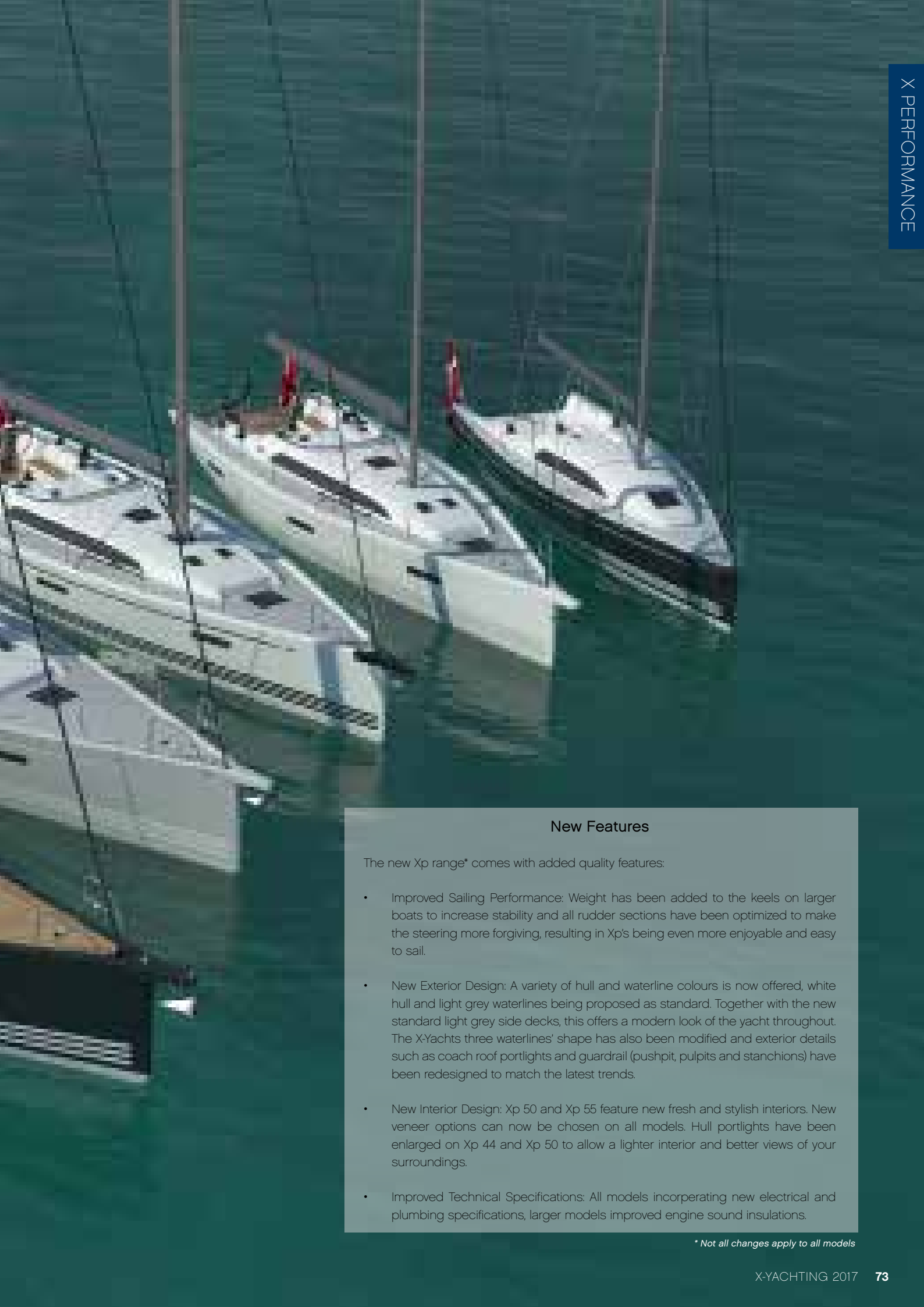

New Features

The new Xp range* comes with added quality features:

- **Improved Sailing Performance:** Weight has been added to the keels on larger boats to increase stability and all rudder sections have been optimized to make the steering more forgiving, resulting in Xp's being even more enjoyable and easy to sail.
- **New Exterior Design:** A variety of hull and waterline colours is now offered, white hull and light grey waterlines being proposed as standard. Together with the new standard light grey side decks, this offers a modern look of the yacht throughout. The X-Yachts three waterlines' shape has also been modified and exterior details such as coach roof portlights and guardrail (pushpit, pulpits and stanchions) have been redesigned to match the latest trends.
- **New Interior Design:** Xp 50 and Xp 55 feature new fresh and stylish interiors. New veneer options can now be chosen on all models. Hull portlights have been enlarged on Xp 44 and Xp 50 to allow a lighter interior and better views of your surroundings.
- **Improved Technical Specifications:** All models incorporating new electrical and plumbing specifications, larger models improved engine sound insulations.

** Not all changes apply to all models*





Xp 33

Pocket Rocket

The smallest member of the Xp range was designed for optimal sailing pleasure and performance

The Xp 33 is a high stability 30-footer which benefits from the same advanced construction techniques as the larger yachts in the Xperformance range, built for superb sailing performance and build quality.

Smooth lines, ample buoyancy both fore and aft, a plumb bow for maximum waterline length and subtle chines create a hull

which is fast on all angles of sail. A custom-designed double spreader aluminium mast is offered as standard, with a carbon rig available as an option. Non-overlapping headsails, a single line headsail furler and retractable bowsprit increase the sailing fun and racing potential while ensuring sail handling is stress-free, even when sailing short-handed.



IMX 70 - X-Yachts 70ft custom build.



Bonding & caulking solutions, the smart choice for yacht building and refitting

NEW MSR DECK CAULK ADVANCED

- Guaranteed quality
- High UV and temperature resistance
- Good resistance against most teak cleaners
- Excellent anti-slip performance on wet decks

SUPPORTED BY A BRAND-NEW DEDICATED MARINE APP

BOSTIK'S MARINE APP INCLUDES:

- Instruction videos for application
- Supporting documentation
- Calculation tool
- Dealer locator

Scan the code or go to the app store and search for 'Bostik marine solutions'.



iOS



Android



SMART SOLUTIONS FOR THE MARINE INDUSTRY

Ship and yacht builders all over the world choose the durable performance of the Simson MSR range and the technical support offered by Bostik's nautical specialists. For more information visit www.bostik.com

Thoughtful design

The Xp 33 deck layout and cockpit is designed to be highly functional. A rod linkage steering system connects to the single rudder underneath the cockpit sole and enables the tiller to be positioned aft, behind the mainsheet. This allows the skipper to easily control the boat when cruising, or to communicate smoothly with the main trimmer whilst racing. The composite tiller is fitted as standard with a Spinlock adjustable extension.

The cockpit is wide and spacious. Aft of the mainsheet track there are moulded foot chocks integrated into the cockpit sole, with two opening

lockers giving access to a generous storage compartment for fenders, mooring gear and similar. Forward of the main track, wide benches offer a comfortable cruising ride and room for race crew manoeuvres. Six Harken winches are fitted as standard, of which two may be easily upgraded to top racing spec.

The Xp 33 may also be easily adapted into cruising mode, with an optional electric anchor windlass and removable stainless steel anchor arm. A self-draining anchor locker is fitted as standard, with gas bottle storage in the port aft cockpit.





YANMAR



**NEW GENERATION
YANMAR JH-CR SERIES**
45 - 57 - 80 - 110 MHP

5 BEST IN CLASS
X



Clean



Interconnective

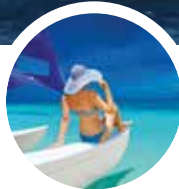

Quiet



Powerful



Fuel Efficient

JH-CR Series
MARINE COMMON-RAIL ENGINES



Whether it is for a brand new sailing yacht or repower, YANMAR has the perfect engine for your X-Yacht. Our engineers have strived to provide you with a unique engine that is powerful, yet smooth and quiet. Our mission to support a better tomorrow has resulted in an engine that is compliant with strict emission rules, producing hardly any visible smoke or odor. All of this, combined with YANMAR's unequaled reliability and service, assures you will enjoy many years of carefree yachting.



YANMAR Marine is pleased to offer you an additional three years of YANMAR Limited Warranty for the complete JH-CR engine series. Please check the Limited Warranty Handbook for full terms and conditions. Or contact the authorized YANMAR distributor/ dealer in your area.

PROVEN MARINE TECHNOLOGY

Spacious living

The Xp 33 is offered with a classic three cabin interior layout. The main saloon includes two comfortable sofas and a removable central table with integral storage, while the engine is easily accessible thanks to a removable GRP cover beneath the companionway. Aft are two symmetrical cabins, while forward there is an optional comfortable and private triangular berth. A single heads with shower is forward of the saloon.

A practical galley lies to port with GRP worktops, a two-jet gimbaled gas stove and stainless steel sink. To starboard a forward-facing navigation station includes the yacht's electrical switchboard as well as space for additional navigation and communication equipment.



Xp 33 Dimensions – Standard

LOA (including anchor roller)	10.27 m	33.80 ft
Hull length	9.99 m	32.78 ft
LWL	8.86 m	29.07 ft
Beam	3.21 m	10.53 ft
Standard draft	1.90 m	6.23 ft
Ballast (standard keel)	1700 kg	3,748 lbs
Displacement (light)	4,300 kg	9,480 lbs

ENGINE / TANKS

Engine diesel	14.5 kW	20 HP
Water tank (standard)	110 Ltr	291 (US) Gal
Fuel tank (standard)	50 Ltr	13.2 (US) Gal

SAIL AREAS (standard)

Mainsail	33.8 m ²	364 ft ²
Genoa (106%)	29.2 m ²	314 ft ²
Asymmetric spinnaker (cruise)	93.0 m ²	1,001 ft ²





XP 38

Global enjoyment

The Xp 38 delivers an unrivalled sailing experience in a dual-purpose cruiser-racer



The Xp 38 has rapidly developed into a global fleet, with boats sold in countries from Japan to Hungary, and Switzerland to Australia. It has been nominated for Boat of the Year, with one judge commenting: "The main reason you own this boat is because you love sailing. Seeing it underway, it just lights you up." (Tim Murphy, Cruising World).

This enjoyment comes from the Xp 38's

high level of responsiveness, thanks to high ballast ratio, light and stiff epoxy infusion construction and carbon keel structure, and controllable sail plan. High stability and ease of handling makes the Xp 38 a rapid and comfortable yacht to cruise with excellent sea-keeping in all conditions, as well as a high performance racing design for both inshore and offshore. It has additionally scored a host of race victories under both IRC and ORC.



Clean ergonomics

Deck-recessed halyards and control lines, flush deck hatches and port-lights create a clutter-free and aesthetically appealing deck layout.

The newly designed pushpit, pulpits and stations along with the new hull colour options, waterline stripes and window style gives the Xp 38 an updated, modern exterior style. Design details include an optional folding

table concealed within the cockpit sole, with dedicated storage for all the essentials – even the washboards. The twin composite wheels are offered with a range of pedestal choices, including compass and instrument mounts, together with optional electric or high-powered manual winches.

The standard rig package includes an aluminium mast with discontinuous rod rigging and hydraulic backstay for efficient

and repeatable tuning. The Xp 38 was also conceived with an optional deep draft keel configuration with high aspect ratio fin, carbon rig and performance deck gear. As with all the Xp models, the composite keel features a lead bulb and cast iron fin, precision moulded and encapsulated in a vacuum infused GRP layer for a perfect, hydrodynamic finish. Through-hull fittings are also recessed to reduce underwater drag, together with a faired 'S-drive' engine strut.

Multiple choice

The Xp 38 includes both classic three-cabin or spacious two-cabin layout options. The three double cabin option includes symmetrical aft berths (which may have optional freeboard shelves or pipe cot berths added) and a master double forward. It comes as standard with the Xp sliding chart table, or an optional fixed

aft-facing chart table, and a heads to starboard with shower over.

The two-cabin option creates an extra large heads, with separate shower featuring hinged door and seat, and a spacious storage locker to starboard that is accessible from the cockpit and can accommodate all cruising equipment.

There is a fixed forward-facing chart table, and double cabin to port.

Both layout options include an L-shaped galley, folding saloon table surrounded by L-shaped sofa, additional seating and generous storage. It is offered in a range of interior colourways, with a wooden galley option also available.



New optional black / grey hull with white new style waterline stripes. Updated pushpit & pulpit. New style coachroof windows.



Standard white hull with light grey new style waterline stripes and light grey sidedecks. Updated pushpit & pulpit. New style coachroof windows.



A QUESTION OF RELIABILITY

Sailing is about the forces of nature, and all the equipment and knowledge that you rely on to catch the best winds. However, it's also about knowing that you can rely on your engine, anytime you might need it. Please visit www.volvopenta.com

**VOLVO
PENTA**



Xp 38 Dimensions

LOA (including anchor roller)	11.95 m	39.20 ft
Hull length	11.58 m	37.99 ft
LWL	10.36 m	33.99 ft
Beam	3.70 m	12.14 ft
Draft - standard	2.10 m	6.89 ft
Draft - deep	2.40 m	7.87 ft
Ballast - standard	2,760 kg	6,085 lbs
Displacement - empty	6,775 kg	14,936 lbs

ENGINE/TANKS

Engine diesel	216 kW	290 HP
Water tank standard	260 Ltr	688 Gal
Fuel tank standard	150 Ltr	396 Gal

SAIL AREAS standard

Mainsail (Aluminium mast)	48.5 m ²	5220 ft ²
Mainsail (Carbon mast)	49.8 m ²	5360 ft ²
Genoa (106%)	37.1 m ²	3990 ft ²
Spinnaker (all-purpose)	130 m ²	1399 ft ²

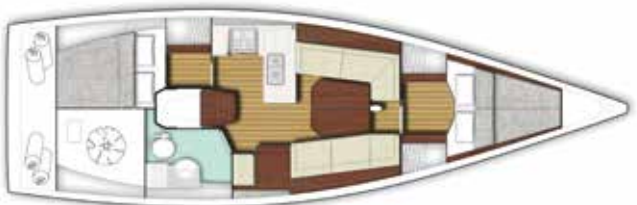
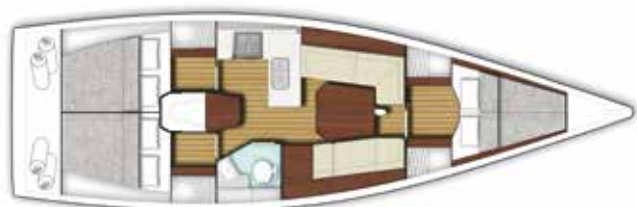



Xp 44

Double the fun

The Xp 44 combines impressive performance with simplicity of handling, appealing to all the family

The Xp 44 was named Sailing World's 'Yacht of the Year' on launching. A highly optimised hull shape offers exemplary performance in a range of wind conditions, on all angles of sail, under both ORC and IRC handicap systems. Key elements of the hull design include reduced upright beam and wetted surface area, while the transom shape ensures that as windspeed

builds and the boat powers up, the overall waterline length increases for additional speed.

Additional performance is gained through the Xp 44's exceptional stiffness and high stability, achieved by a high ballast ratio with additional weight in the keel bulb keel, and lightweight structures thanks to epoxy infusion build processes.





Contemporary design

The Xp 44 introduced the innovative Xperformance bowsprit, with options including a carbon bowsprit to set asymmetrics, a GRP cowling, and optional anchor attachments for hassle-free cruising.

Alone with the rest of the Xp fleet the Xp 44 has had her exterior styling revamped with new colour options, redesigned pushpit and pulpit, new window styles and updated waterlines.

The Xp 44 is supplied with an aluminium rig as standard with carbon mast and boom as an option, both developed in conjunction with leading sailmakers to

create an efficient, easily adjustable sail plan.

The Xp 44 also carries multiple halyard options to allow owners to optimise their boat for racing or cruising, inshore or offshore. Standard deck features include a below decks furling drum, low friction racing blocks, and large self-tailing winches (powered winches optional)

The Xp 44 interior will also undergo a revamp for 2018 with the new oak style finish becoming available to create a more contemporary style. The larger hull portlights and numerous deck hatches allow plenty of light in further adding to

the light and spacious feel. The Xp 44 also introduced the Xp range's adaptable new sliding navigation station, supplied as standard, which allows for additional seating or a forward-facing chart table. It is also offered with a fixed chart table option and wooden galley. The three-cabin layout includes symmetrical double aft cabins, a forward cabin with ensuite heads, L-shaped galley (now available in a new wooden finish option as shown above), additional heads accessible from the saloon, and spacious seating area around a removable saloon table. Flush-mounted hatches and stylish LED lighting creates a light and welcoming space, day or night.



New optional black / grey hull with white new style waterline stripes. Updated pushpit & pulpit. New style coachroof windows.



New optional grey hull with white new style waterline stripes. Updated pushpit & pulpit. New style coachroof windows. Optional bathing platform

Hempel's Mille NCT recommended by X-Yachts

X-Yachts guarantees the best quality equipment on their boats. That is why X-Yachts rely on Hempel for underwater protection.



hempelyacht.com
x-yachts.com



Xp 44 Dimensions

LOA (including anchor roller)	14.25 m	45.00 ft
Hull length	13.29 m	43.60 ft
LWL	11.89 m	39.01 ft
Beam	4.07 m	13.35 ft
Draft - standard	2.30 m	7.55 ft
Draft - deep	2.65 m	8.69 ft
Ballast - standard	3,850 kg	8,488 lb
Displacement - empty	8,650 kg	19,070 lb

ENGINE/TANKS

Engine diesel	30 kW	40 HP
Water tank standard	350 Ltr	92.5 (US) Gal
Fuel tank standard	200 Ltr	53 (US) Gal

SAIL AREAS standard

Mainsail (Aluminium mast)	596 m ²	6420 ft ²
Mainsail (Carbon mast)	642 m ²	6910 ft ²
Genoa 106%	472 m ²	5080 ft ²
Spinnaker	1700 m ²	1,830 ft ²



Xp 50

Aspirational Sailing

The Xp 50 is a high performance cruiser-racer which offers impressive pace and ease of handling

The longer waterline length of the Xp 50 allows additional cruising features to be incorporated, as well as increased straight-line speed.

In line with the rest of the Xp range, the 50-footer utilises epoxy infusion build processes for improved stiffness with reduced weight, a carbon keel structure for maximum safety and ultimate stability, and a

precision-moulded composite keel with iron fin and lead bulb giving a high ballast ratio.

A choice of standard aluminium or optional carbon rig packages, and standard or deep draft keels, allows Xp 50 owners to optimise their yacht for cruising or racing, short-handed or fully crewed, inshore, offshore or bluewater sailing.





New and improved

The new Xp 50 will feature the modernised exterior expression including the light grey side decks, new colour options, updated water lines and newly designed portlights. The pushpit, pulpit and stantation bases have also been redesigned to create a sleek new look.

The 'T' keel and rudder sections have now been optimized for improved performance and to create a more pleasant helming experience.

Xp 50 bowsprit features a removable stainless steel anchor fitting, neatly

integrated as standard below a removable GRP cowling. Alternative options include a carbon bowsprit with or without integrated anchor fitting, for setting large asymmetric and code sails with ease, or a flush cowling.

A flush anchor deck hatch conceals a large 1500W anchor winch and also provides access to a separate sail locker with optional crew berth.

Concealed control lines run aft with a 'Maxi-style' mainsheet system for a clutter-free, functional and comfortable cockpit area. There is a choice of biminis and two-pole sprayhood with opening window, together

with the Xp folding cockpit table for flexible entertaining space.

Liferaft storage is integrated under the cockpit sole, while the transom garage accommodates an inflatable tender.

An electrically operated transom door also forms a teak-topped bathing platform with stainless steel swim ladder.



New optional black / grey hull with white new style waterline stripes. Updated pushpit & pulpit. New style coachroof windows.



New optional light grey hull with white new style waterline stripes. Updated pushpit & pulpit. New style coachroof windows. Optional teak decks







New optional Oak interior with Walnut cabin sole



New style double berth in owners cabin



Light & roomy

The Xp 50 interior is dominated by a feeling of light and space thanks to the numerous skylights, the large coach roof windows and also thanks to its new oak finish on bulkheads and joinery. The walnut floorboard gives a new character to this now very bright interior.

The Xp 50 hides an incredible amount of storage all around, in overhead lockers along the entire cabin length, under sofas and in many very practical lockers.

The two large hull portlights in the saloon offer a great view on the outside scenery from the 6 people saloon sofa and the starboard bench. The new version is also offering a new optional adjustable saloon table whilst the standard version includes a bottle storage.

The large U-shape galley offers safe and comfortable conditions to cook at sea and includes all the essential elements to make

you feel like at home: large top-loading fridge-freezer completed with an optional 85-litre front-opening fridge, a built-in microwave storage and a Corian worktop.

On starboard, the owner can chose between three different chart table options, a forward facing dedicated navigation station, an aft facing chart table with instruments hidden behind overhead locker doors or a sliding module which offers both advantages of facing forward at sea whilst taking very little space the rest of the time

The Owner's cabin has been largely revisited for the new version of the Xp 50. Both the feel of space and the storage capacity have been optimised to guarantee compatibility with a cruising program. The berth is hiding large amount of organised storage, accessible via drawers and lifting mattress. Larger window apertures in all cabins now provides with even more light and visibility to the outside.





PERFORMANCE DYNAMIC SAFETY

High Tech Yacht Ropes
Made in Germany

www.liros.com





Xp 50 Dimensions

LOA (including anchor roller)	15.78 m	51.80 ft
Hull length	14.99 m	49.18 ft
LWL	13.31 m	44.00 ft
Beam	4.41 m	14.53 ft
Draft - standard	2.65 m	8.69 ft
Draft - deep	3.00 m	9.84 ft
Ballast - standard	5,140 kg	11,332 lbs
Displacement - empty	11,900 kg	25,573 lbs

ENGINE / TANKS

Engine diesel	55 kW	77 HP
Water tank standard (US)	550 Ltr	145.5 Gal
Fuel tank standard (US)	300 Ltr	79.5 Gal

SAIL AREAS (Standard)

Mainsail (Aluminium mast)	876 m ²	9430 ft ²
Mainsail (Carbon mast)	896 m ²	9650 ft ²
Genoa 106%	643 m ²	6920 ft ²
Spinnaker	2100 m ²	2,368 ft ²

New optional light grey hull with white new style waterline stripes. Updated pushpit & pulpit. New style coachroof windows. Optional teak decks







Xp 55

Above and beyond

The Xp 55 is the flagship model in the Xp range and raises the bar for performance sailing yachts

The Xp 55 offers an unbeatable sailing experience combined with luxurious levels of comfort. Since its launch, it has impressed reviewers and sailors alike, with test reports praising the boat for its 'dinghy-like feel', fast pace, and the ability to sail the boat rapidly and easily double-handed.

Although the largest yacht in the range, the Xp 55 is designed for ease of short-handed cruising. Utilising the same hi-tech construction methods as the rest of the Xp range, the Xp 55 has an impressive ballast ratio for her size for controllable, stable high performance sailing.



New optional light grey hull with white new style waterline stripes. Updated pushpit & pulpit. New style coachroof windows. Optional teak decks

Ease of handling

The Xp 55 deck layout's qualities are not only carried over onto the 2018 Edition, but also improved on!

As a fast cruiser, designed to be manageable even by a short-handed crew, all the control lines, sheets and halyards are led back to the four generously dimensioned winches for easy access from the helm station. Under deck genoa furler and longitudinal tracks with control line are fitted on the standard boat. In the 2018 version, new optional halyard storage will be available to make the working area even tidier and more organised. Thanks to this arrangement, the cockpit remains tidy and clear during manoeuvring, for guests to enjoy a restful sail.

Most lines running under-deck into watertight channels makes the Xp 55 deck

visually pleasing, and safer for all.

For the most meticulous sailors, jibs, spinnakers and mainsail have got optional inner-haulers to always achieve the perfect setting and get the most out of the efficiently designed hull. The optional bowsprit, now coming in two different lengths, allows asymmetric spinnakers up to 240 m² to be flown whilst also neatly housing the standard anchor arm.

The large amount of instrument support options offered by X-Yachts means that the electronic layout can be tailor-made to the owner's preference.

Along with the other models of this range, the Xp 55 2018 Edition is now available with a large choice of hull colours, grey side decks as standard and dark grey helm stations.

The new coach roof glass portlight, pulpit, pushpit and stanchion design as well as hull décor give this already successful yacht an exciting new modern look.

The electrically operated folding transom can be deployed to create a welcoming teak-topped bathing platform for easy access to the water or tender.

The garage accommodates all leisure equipment and is also able to house a tender up to 3.0 - 3.2 m in length.

In the forepeak there is a large sail locker that can also be used for storing the fenders, keeping the cockpit lockers free for other equipment.



30% off for all X-Yacht Owners



Go to www.atnordicshop.dk/ to shop for our range of X-Yachts Slam clothing

SLAM
X-YACHTS OFFICIAL
CLOTHING SUPPLIER



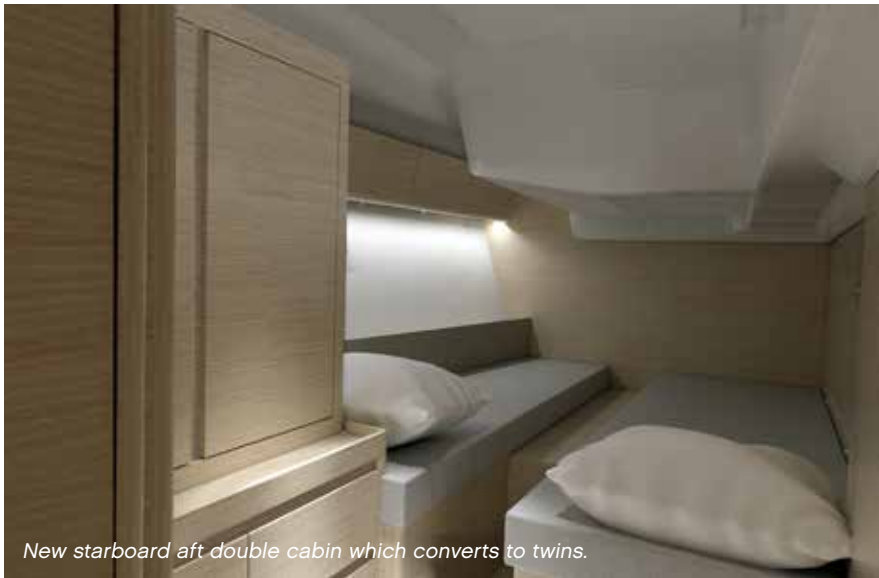

New starboard aft double cabin which converts to twins.



Newly designed spacious bathroom



Personal Perfection

The Xp 55 interior offers an exceptional level of customisation, with a choice of layouts and finishes. The newly revamped model delivers a modern stylish interior with the new lighter oak option for a light and airy feel. The numerous large deck hatches as well as the new larger hull windows allow an impressive amount of light to flood in and fill the space as well as offering spectacular views.

The master cabin features a large double bunk which when fitted on the centreline has been cleverly redesigned with a smaller base to create a more spacious floor area, while still retaining a large amount of storage space. The en-suite is to port and creates a luxurious, self contained owners suite. Alternatively the bunk can be fitted to port with the en-suite forward including

direct access to the sail forepeak and sail locker.

The aft symmetrical cabins may now be split to create two twin bunks or with the use of an infill a large double offering truly versatile accommodation. If even more accommodation is needed the aft cabins can also be fitted with optional pipecots.

There is a choice of a single second heads and wet room accessible from the main saloon, which also allows for an extra spacious galley, or twin ensuite heads for the aft cabins.

The large U-shape galley offers safe and comfortable conditions to cook at sea and includes all the essential elements to make you feel like at home such as

triple-jet gas oven, microwave, top-loading fridge-freezer, front-loading fridge and ample storage. There is also space for optional appliances such as a dishwasher or Nespresso coffee machine.

Other options include a concealed lifting television in the saloon, and a choice of high quality materials including Corian galley worktops and hand-crafted carpentry.

If you are looking for a yacht that will sail beautifully and perform well in all conditions but are unwilling to compromise on the interior luxury, fit out, and style then the new Xp 55 offers a truly unique mix to keep even the most demanding of sailors happy.



New optional Oak interior with Walnut cabin sole



New style double berth in owners cabin

Gori[®] propeller

experience the difference



Now 3 blade also available without overdrive function



www.gori-propeller.dk



Xp 55 Dimensions – Standard

LOA (including anchor roller)	17.23 m	56.50 ft
Hull length	16.76 m	54.99 ft
LWL	14.87 m	48.79 ft
Beam	4.77 m	15.65 ft
Draft - standard	2.85 m	9.35 ft
Draft - deep	3.2 m	10.5 ft
Draft - shallow	On request	
Ballast - standard	6300 kg	13,889 lbs
Displacement light	16,800 kg	37,038 lbs

ENGINE / TANKS

Engine diesel	80.2 kW	110 HP
Water tank standard	550 Ltr	145 (US) Gal
Fuel tank standard	400 Ltr	105 (US) Gal

SAIL AREAS (Standard)

Mainsail (Aluminium mast)	996 m ²	1,0721 ft ²
Mainsail (Carbon mast)	102.8 m ²	1,106.5 ft ²
Genoa 106%	74.8 m ²	805.1 ft ²
Spinnaker	2400 m ²	2583.3 ft ²



Simply X

Xp for Xperformance, Xc for Xcruising, simply X for the best of both worlds

Aimed at the discerning sailor, the X range is designed to meet the demands of sailors who want to enjoy sailing in a wide variety of conditions as well as have all the luxury you would expect from the clean, timeless Danish style, synonymous with X-Yachts.

The first X4³ and X6⁵ were launched last summer and since then have proved to have exceptional sailing abilities as having a spacious airy interior oozes style and luxury whilst also being functionally designed to work either at sea or in harbor.





Designer's Corner

The objective

The new 'X' range consists of the X4³ and X6⁵, letting the owner enjoy the best of both worlds - a "modern/sexy" design with high levels of comfort.

The design philosophy was very clear from the outset - like all our ranges, we place a huge emphasis on giving the owner a superb and comfortable sailing experience, on a yacht that is easy to handle by all the crew.

These models are not designed to win races, which means no ORC / IRC handicap rules need to be met. This allows for more room to be innovative and thus we have designed hull lines that are more 'powerful', by widening the bow and stern sections. These changes can hinder performance racing on a windward / leeward racecourse, but improves sailing performance whilst reaching while cruising. Furthermore the wider sections, allow for a bigger interior space and more spacious owner's cabin.

The models will only incorporate the best build technologies. An example is the use of vacuum infusion epoxy sandwich lamination technology with local carbon reinforcements in the hull. Each hull is crafted by a laminating team that have become the biggest producers of high tech hulls in the last four years, with almost 300 built over in this period.

Epoxy not only makes an ultimately stronger construction, but also gives the added advantage, that the hull topsides will remain undistorted, for a much longer period, seeing less shrinking.

X-Yachts will once again introduce a range of head turning yachts into the market and lead the way for connoisseurs who appreciate the same fundamental philosophy:

Enjoying Superb Sailing Pleasure

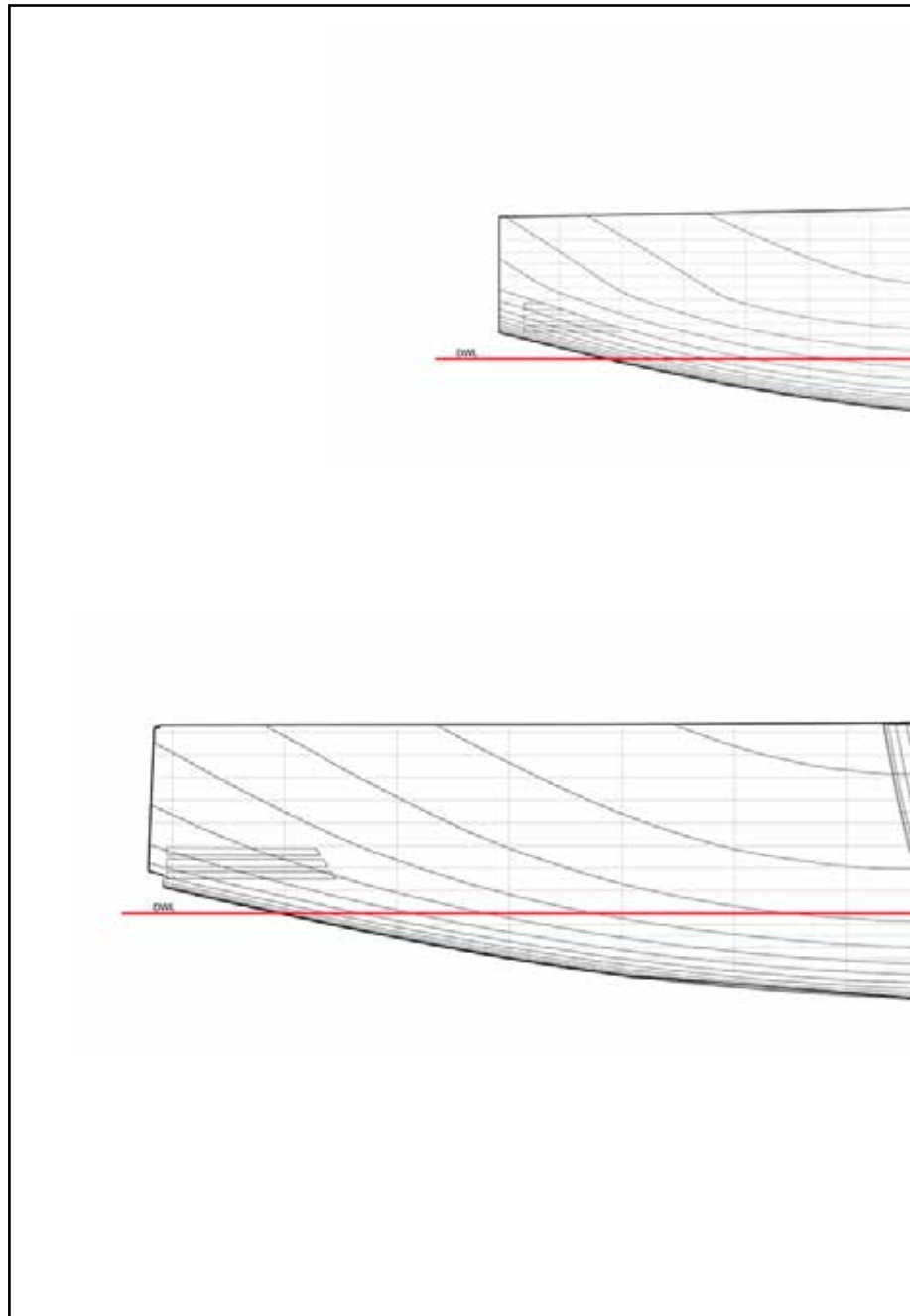

mmments

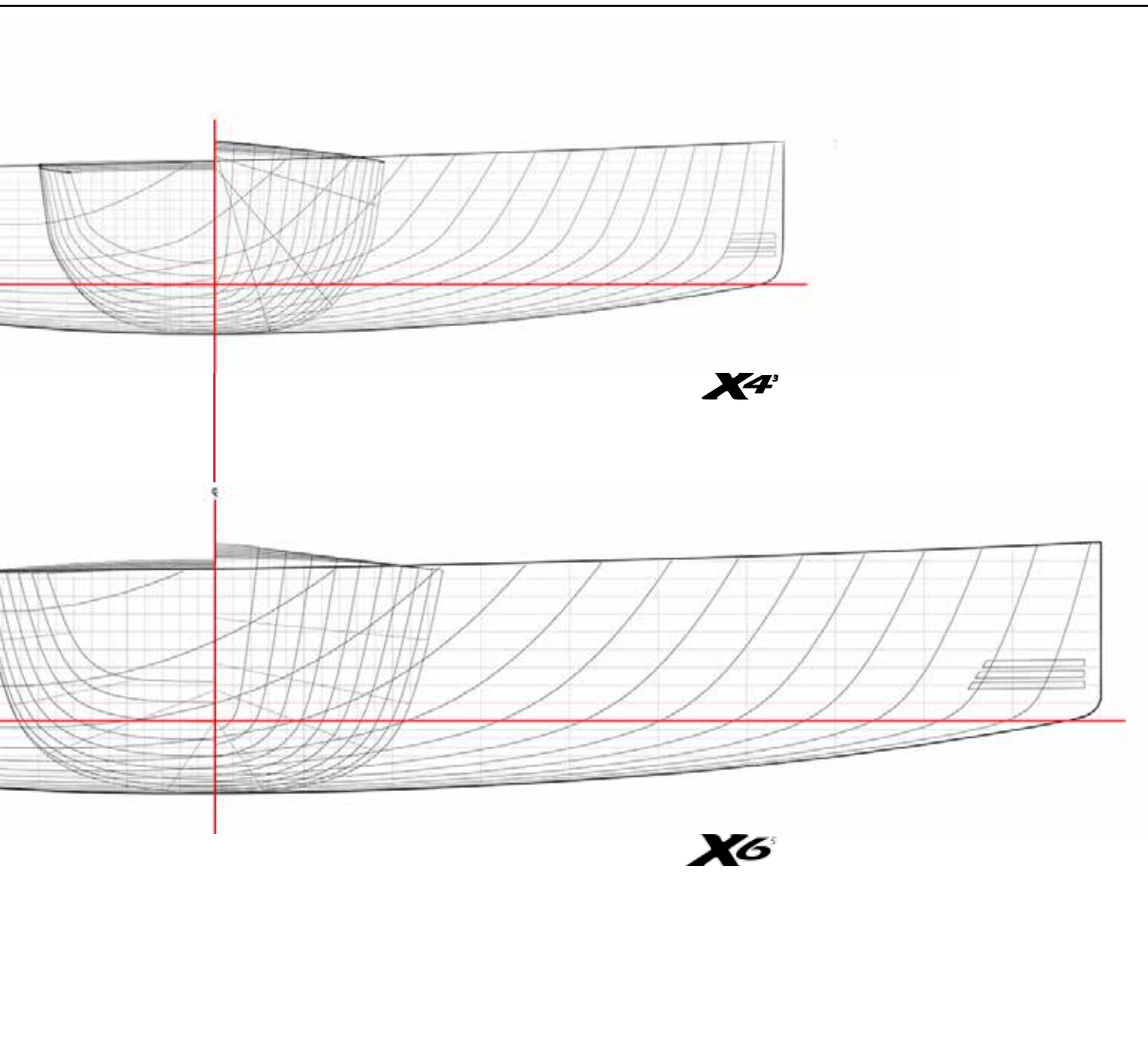





X4³

Luxury lines

The new X4³ offers the perfect combination of performance, style and luxury.

The all new X4³ was launched in summer 2016 and has already been nominated for European Yacht of the Year and won Cruising World's 'Best full-Sized Cruiser Under 50ft'

With a substantial keel weight and

sail plan, the X4³ is a dream to sail into wind and waves. The increased load on both the hull and rig makes it also necessary to increase the specification for the dimensions of the deck gear, winches, clutches etc., resulting in ultimate sailing pleasure.

“

ONE OF THE BEST BOATS I HAVE EVER SAILED

GRAHAM SNOOK, YACHTING MONTHLY

”



Optimal luxury

Over the past two years, interior designers and carpenters have been striving to reach an "expression" for the X6^s, normally only seen on larger super yachts. The X4^s interior will be incorporating inspiration from the evolution of this design process.

There is a galley worktop surface in Corian with integrated double stainless steel sinks, a quality mixer faucet, built-in top loading

cooling box (alternatively a freezer), fully gimballed oven and space for additional front opening fridge and coffee machine.

New stylish bookshelves, located behind the nav station and recessed into the bulkhead separating the owner's and sails cabin, add to exquisite interior detailing along with a large comfortable owner's berth thanks to an increased hull beam. berth,





OUTDOOR LIVING

The cockpit space on board the X4³ is not only designed to be functional and safe while at sea but has also to create a luxurious outdoor living space.

The twin wheels and recessed mainsheet track mean the cockpit area is spacious and uncluttered. The teak cockpit sole and seats come as standard on the X4³.

There is a choice of cockpit tables available including fixed versions with integrated chart plotter and instruments or

a removable easily stowable version. Both offer plenty of space for al-fresco dining.

The optional fold down swimming platform creates a perfect area for relaxing as well as easy access from the water or dinghy. A deck shower is fitted as standard.

The high back rests not only offer protection while at sea but also create a comfy seating area, especially with the addition of the fitted cockpit cushions.





X RANGE



FROM THE DECK UP

X4³



**WE ARE PROUD TO DELIVER COMPLETE
SAIL HANDLING FOR THE X4**

**MAST • BOOM • RODKICKER • HYDRAULIC BACKSTAY
TENSIONER • FURLEX THROUGH DECK • DECK HARDWARE**

Seldén is the world's leading manufacturer of rig systems,
providing cruisers and racers sailing pleasure since 1960.



 **SELDÉN**
for sailing

www.seldenmast.com

Many choices

The high number of deck skylights and port lights, including those facing forward and aft give the interior a light, spacious and roomy feel whilst the double ended main sheets system is lead to two dedicated main sheet winches.

On deck, there is a mainsheet track which is recessed into the cockpit floor, a dedicated life raft compartment aft of the helmsman and four spacious cockpit lockers.

X4³ Dimensions

LOA (including anchor roller)	12.91 m	42.40 ft
Hull length	12.50 m	41.0 ft
LWL	11.31 m	37.1 ft
Beam	3.95 m	13.0 ft
Standard draft	2.20 m	7.2 ft
Standard draft (L-keel)	1.85 m	6.1 ft
Deep draft (L-keel)	2.50 m	8.2 ft
Ballast (standard)	3,800 kg	8,378 lbs
Displacement (light)	8,850 kg	19,511 lbs

ENGINE/TANKS

Engine diesel	33 kW	45 HP
Fuel tank	200 Ltr	52.8 Gal (US)
Water tank	340 Ltr	89.8 Gal (US)

SAIL AREAS

Mainsail (aluminium mast)	54.0 m ²	581.3 ft ²
Mainsail (carbon mast)	54.0 m ²	581.3 ft ²
Genoa (106%)	43.0 m ²	462.8 ft ²
Spinnaker	15.0 m ²	161.46 ft ²
Spinnaker (asymmetric)	101.14 m ²	1,089 ft ²



Forward heads is optional

X6⁵

New State-of-the-Art

The X6⁵ is sure to turn heads wherever she goes

The X6⁵ is the first model in the new X range. The model comes with a comprehensive range of options to help tailor each individual's sailing experience. The options include solar panels recessed into a carbon bimini, space for a Williams jet rib in the stern garage and teak on not only the cockpit and deck but the side deck and coach roof as well as carbon rigging.

The X6 has been designed to ensure optimal pleasure. The coachroof is raised to allow for a panoramic view and increased natural light when below deck whilst the cockpit area comes with a table with adjustable legs which can be lowered to either coffee table height or to support a large sun bathing area as standard.





*“ I HAVE NEVER WALKED INTO A BOAT BEFORE AND
FALLEN STRAIGHT IN LOVE WITH IT LIKE THIS ”*

RICHARD LANGDON, YACHTING WORLD

READY. STEADY. GO.

RECKMANN RIGGING HYDRAULIC SYSTEMS

The optimum combination of performance, ease-of-use and fast results. Experience state-of-the-art manufacturing made by Reckmann, Germany.

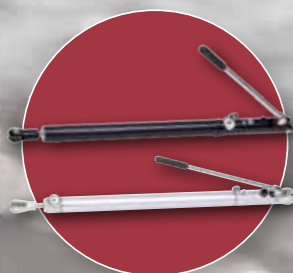

Siemensstraße 37–39
D-25462 Rellingen

Tel. +49(0)4101-3849-0
Fax +49(0)4101-3849-50

www.reckmann.com
info@reckmann.com



REEFING SYSTEMS & HYDRAULICS



OUTDOOR LIVING

The cockpit area can be customised to your needs, offering a table with adjustable legs, which can be lowered to either coffee table height or to support a large sun bathing area as standard. Optional cockpit cushions are held in place with fitted aluminium sections holding each cushions boltrope. Optional cockpit fridge is located in the aft part of the port side cockpit U-sofa arrangement.







Interior indulgence

Danish design and architecture is famous for its clean, timeless style. It showcases luxury whilst also being functionally designed to work either out on the open seas or moored up in harbour.

Superior quality, detailed interior carpentry and materials used sets it apart from mass produced boats, producing an exquisite, natural interior. The panoramic deck saloon windows and hull portlights allow for ample light to flood in, gifting the interior with a bright and airy ambiance.

Plentiful storage space throughout allows for an uncluttered, 'live on board' lifestyle, giving a place to retreat to when the weather outside is less forgiving.

The bulkhead-recessed shelves can accommodate books and decorative items along with integrated, ambient LED lighting in the saloon whilst the galley offers a spacious area to cater for everyone with white painted and hand polished satin finish and worktops in black Corian (other options available).

The space is designed around the 'Gastronorm Catering System' which transforms the space into a more functional and significantly safer place to prepare and cook food whilst at sea.



WINNERS CHOOSE AXXON

... it is not a coincidence ...



So, which boat has the Axxon carbon mast ?...



The innovative carbon mast company

AXXON COMPOSITES

www.axxoncomposites.com

sales@axxoncomposites.com



Owner's Quarters

Owner's cabin located in front of the mast, with easy to reach storage space under the large double berth. All berths have comfortable, double density foam mattresses which rest on laminated curved battens, providing ultimate ventilation and well-being.

Inside the luxurious owner's heads, there are electrical flushing toilets and dedicated shower rooms in all layout options.





NO PASSION
WITHOUT RISK ...

... LEAVE THE RISK TO US.

HB
HINBERG ROSENBERG
11/12
2012



PANTAENIUS
Yacht Insurance

Now also in Australia

PANTAENIUS.COM/PASSION

Germany · Great Britain* · Monaco · Denmark · Austria · Spain · Sweden · USA** · Australia

*Pantaenius UK Limited is authorised and regulated by the Financial Conduct Authority (Authorised No 308688) **Pantaenius America Ltd. is a licensed insurance agent licensed in all 50 states. It is an independent corporation incorporated under the laws of New York and is a separate and distinct entity from any entity of the Pantaenius Group.

Customisation

The X6⁵ rewards the owner with a deck and rigging layout fit for a king. Halyards and control lines are led back to the aft cockpit coamings, making for a clutter free environment. It is decked out with vacuum applied laid teak on sidedecks, all seating, cockpit sole and inside of the transom door / swim platform.

Short handed sailing is easily controlled by four electrical self-tailing winches for sheets, halyards and reef lines, all positioned within easy reach of the helmsman. The optional halyard winches can either be mounted on the deck by the mast or on the mast itself and the 106% furling genoa is easily controlled with an electrical Reckmann headstay furler that comes as standard.

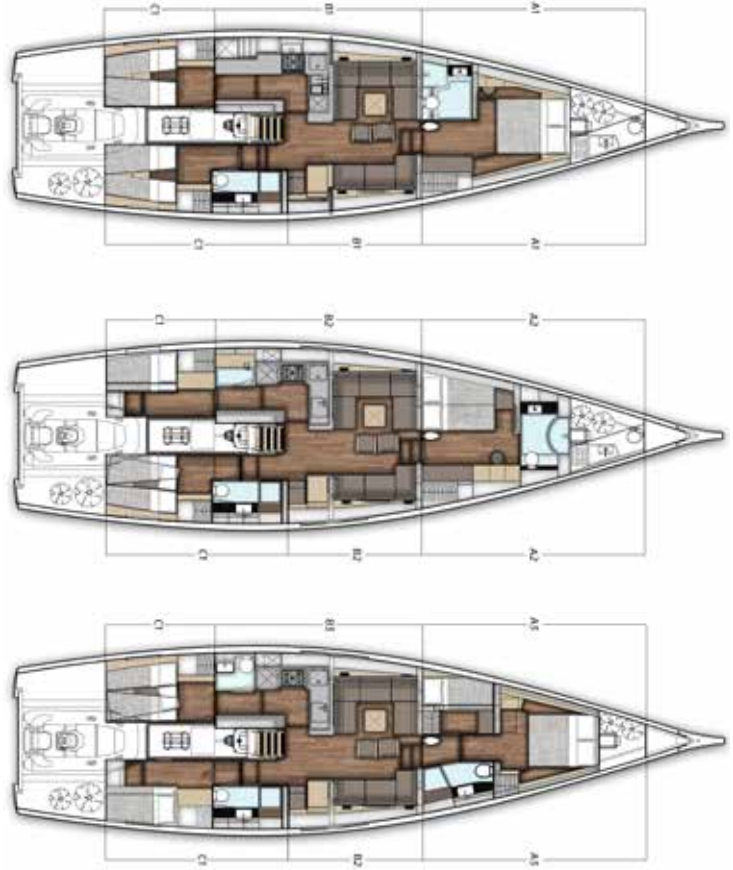

X6⁵ Dimensions

LOA (including anchor roller)	20.10 m	66 ft
Hull length	19.19 m	63.1 ft
Waterline length	17.85 m	58.6 ft
Beam	5.40 m	17.8 ft
Draft (option A: L-keel)	2.6 m	8.5 ft
Draft (option B: T-keel)	3.0 m	9.8 ft
Draft (option C: T-keel)	3.4 m	11.2 ft
Displacement (keel option B)	29,500 kg	65,030 lbs

ENGINE/TANKS

Engine (standard)	119 kW	160 HP
Fuel capacity	1,200 Ltr	317 (US) gal
Water capacity	1,000 Ltr	264 (US) gal

SAIL AREAS

Mainsail	130 m ²	1,399 ft ²
Genoa (106%)	90 m ²	969 ft ²
Asymmetric spinnaker	280 m ²	3,014 ft ²

Xp44's dominate around the world



There's quite simply no stopping the Xp44's at the moment with victory's in some of the most prestigious yacht races in the world both state side and in the Med.

NEWPORT – BERMUDA RACE “WARRIOR WON” - 1ST OVERALL

Few tests of blue-water seamanship are as iconic as the 635-mile Newport Bermuda Race. The yacht Warrior Won, an Xp44, skippered by Christopher Sheehan of Larchmont (NY) Yacht Club took the main prize, the St David's Lighthouse Trophy. This silver replica of the islands landmark lighthouse is awarded to the boat in St. David's Lighthouse Division that is first on handicap corrected time. This division was the largest in the fleet with 110 entries.



GIRAGLIA ROLEX CUP – “AMBER MILLS” - 1ST IRC-A

The Giraglia Rolex Cup is one of the most important racing event in the Mediterranean calendar. It combines offshore passage races along with a number of inshore races. This year in the overall combined results for in inshore and offshore races Xp44 Amber Mills took 1st place in IRC-A, This is a great achievement as she is sailing against some of the most famous racing yachts in the world. Thanks to photographer Carlo Borlenghi for this great photo!

DOWN THE BAY RACE FOR THE VIRGINIA CRUISING CUP - "SITELLA" – 1ST OVERALL

Congratulations to the crew on board Sitella for winning the 67th "Down the Bay Race" a 120 nm course from Annapolis, MD to Hampton, VA.

Not bad going considering their new Xp44 was only delivered this Spring!

Ian Hill and his crew who had never previously skippered an entry in the venerable event, was presented with the Robert M. Ravin Memorial Trophy for fastest elapsed time and the prestigious Virginia Cruising Cup as overall winner on corrected time.



ANNAPOLIS – BERMUDA OCEAN RACE - XP44 "RIVAL" - 1ST OVERALL & LINE HONERS

Bob Cantwell and the crew of Rival took line honers in the recent Annapolis – Bermuda yacht race against 25 other yachts. It is hardly surprising that she did so well considering she was hitting speeds of 22knots!!



KIEL WEEK 2016 – XP44 X-DAY – 1ST ORC II & 1ST GERMAN OPEN ORCII CHAMPIONSHIPS

Max Gurgel and his crew on board X-Day have come 1st in ORCII in this year's Kiel Week. This is one of the biggest sailing events in the world with yachts and dinghies of all ages and sizes taking part. Taking place so close to X-Yachts HQ meant there were a number of X-Yachts taking part in the event, with 5 in ORC II alone!! In winning this event they have also now won the overall German ORCi Championships. This is a remarkable achievement especially

for a yacht that has not been overly optimised for racing. She has the Standard keel, standard rig and standard sails... Just goes to show that the Xp44 is a super competitive boat event without the added extras!

X-Yachts Solent Cup

RSYC, 29th April - 1st May 2016

From 29th April to 1st May this year's X-Yachts GB Solent Cup returned to Hamble and The Royal Southern Yacht Club, who took care of the racing and our onshore entertainment.

22 X-Yachts were entered in to the regatta and were split between 3 classes. Sports A for racing yachts over 40ft, Sports B for racing yachts under 40ft and the family class for the non spinnaker boats



Friday brought the Skipper's Briefing, followed by the X-Yachts Owner's Association Drinks. Crews were happy in the Upper Bar with everyone joining for the Hog Roast.

On Saturday morning the yachts headed out in to the Solent to the start area around Roger Swinney buoy to the eastern end of Ryde Bank. After some delay whilst the wind settled, Race 1, a windward leeward race over Ryde Bank, was announced. Sports Class A started their first race, with Clive Buesnal's X-50 "Exhilarance" winning the line with a great start, however Andrew & Lee Bollers X-65 "Katherine" soon got up to 10 kts upwind, and carved through the fleet. However, due to an issue with the furling mechanism of the gennaker,

"Katherine" was unable to unroll the large downwind sail and struggled to sail to her handicap. This made for some very close racing, with a very close call to who would be first around each mark. Demian Smith and his family aboard Xp 44 "Simples" were taking the day very gently, as it was the first days sailing aboard his new yacht, however still managed to keep up with her larger sister, the Xp 50 "Xtravagance" owned by Anton Jenkins. In Sports Class B Peter Hodgkinson and Sarah Bailey's X-362S "Xcitable" lead the way. It was important to navigate on the bank to windward and slightly to the north of the bank for the return under spinnaker in order to play the tides. "Xcitable", proved the point with a clear win over the X-37 "Unruly" (Charles and Ellen Bull), followed closely by the

X-332 "La Nef IV" (John Noë).

Race 2 took us over towards the Bramble Bank with the windward mark Kilchoman. Again, after a clean start, the whole fleet set off across the Solent towards the mainland shore. Only La Nef IV thought that Ryde Bank would be the paying tack. How wrong they were. Those who went over to the mainland had slightly more breeze and a good lift towards the mark. The first retirement of the day occurred when the X-119 "IN X Celsis" (Peter Jones) caught the leeward mark and tried to take it with him. After 2 laps of the course, once again "Xcitable" lead the fleet, but this time the other X-362 "Magec" (Mike Garvey) was in hot pursuit. The finish was in that order with the X-99 "2XS" (Aindriu McCormack)

some 5 minutes later in 3rd place. As for La Nef IV, just as she was rounding the leeward mark for the last time, albeit way behind most of the fleet, the 30Kn squall which was to cause the abandonment of racing for the day, hit as she was dousing the kite. All mayhem broke loose on board. The spectacle of the yellow and black spinnaker flying from the top of the mast was for all to see! Sadly she had to abandon as a result.

The Family Class sailed a slightly different course and saw "Xstream" lying in 1st position with the Xc 38 "Xtension" a close 2nd and Peter Tanner's Xc42 "Oojah" lying 3rd.

Saturday afternoon's Mount Gay Rum reception was sponsored by North Sails. The onshore Beat The Bleep competition

was fun for all involved with Ed & Al entertaining us in the background. This set up a nice atmosphere before our Gala Dinner.

The Gala Dinner was attended by c. 150 people, who were entertained by after-dinner speaker Mick Dawson, who reiterated his story of rowing across the Atlantic and Pacific Oceans. His honest and down to earth delivery engaged and enthralled all guests after the flavorsome Gala Dinner.

Sunday also brought perfect sailing conditions, Champagne sailing was the order of the day for the whole of racing. The wind had turned SW, so our race officer put the start line much nearer home around the Royal Southern Buoy. In Sports Class A "Simples" was pushing a little harder, and

managed to sail the right angles downwind with the large A1.5, while "Xtravagance" struggles slightly with the snuffer on their large running a-sail. Sadly Katherine was unable to use the asymmetric again, however they were delighted to win the moral victory with line honours in each race that day! The Family Class sailed the ever popular pursuit race on Sunday and saw Ian Miller's Xc 38 "RefleXion" set off first, followed by Anne Gunter's Xc 42 "PresenXe". The larger Xc overhauled "RefleXion", and then maintained her lead through to the finishing line. A steady procession followed within minutes, as testament to the pursuit race handicaps.

As racing came to a close, Gwynne and Tracey Lewis on the X-34 "Aura" held off "Xstream" on the final leg. With "Xtension" lying ahead of Aura, "Xtension" reversed the day 1 top slots and became the overall family class winner for 2016, with "Oojah" remaining in 3rd position.

On Sunday after racing, the fleet made their way back to The Royal Southern Yacht Club for after racing Fish & Chips, along with a Dark & Stormy drinks reception in conjunction with the Prize Giving. A lot of the crew viewed the weekend as a social event as well as some fun on the water. Thanks to the Royal Southern Yacht Club for being great hosts. We are looking forward to returning in the future.



Solent Cup Results

Xp44 "Simples" - Demian Smith - 1st Sport Class A

X382S "Xcitable" - Peter & Sarah Hodgkinson - 1st Sports Class B

Xc 38 "Xtension" - Brian Carlton- 1st Family Class

X382S "Xcitable" - Peter & Sarah Hodgkinson - 1st Overall

X-Yachts Ostsee Cup

Heiligenhafen, 13-15. May 2016



There was a lot of excitement at the bridges in front of the sail loft from Doyle Oleu-Segel. During the day, on this sunny Friday the 13th May, lots of X-Yachts reached their berth in the harbour ready for the 2016 X-Yachts Ostsee-Cup. In the evening Oliver Leu welcomed nearly 200 participants with family's and friends and made sure that everybody was looking forward for the upcoming event and races.

The boats started in 4 different groups. 2 Family classes and 2 racing classes divided by the size of the boats.

On Saturday there were 2, short, windward / leeward races planned, but this plan was changed because of the weather forecast for the day. On the Fehmarn-Sund there was a high steep wave with gusty winds of 25kn plus, so the new plan was to do a medium distance race to make the day much more comfortable and easier for all

the boats who are not racing a lot. On the other side it was made sure that there were enough windward / leeward parts to satisfy the racing classes.

This decision was welcomed from all participants.

So the Saturday's race started in time with spectacular conditions.

Afterwards the crew could relax and enjoy a great dinner and evening hosted direct in the sail loft from Doyle Oleu-Segel.

The second racing day on Sunday starts similar to the day before, with a lot of wind. But it wasn't as sunny as Saturday. On this day there was also a medium distance race of approximately 20 nm.

For a lot of the crews this was a challenging days. Caused by the higher wind speed and the short, bigger waves, which built up over the day.

Some Crew had to suffer with small hail squalls or some minor damages. At the end of the day everybody was a bit

exhausted but also glad and contended. The prize giving followed a superb dinner.

This X-Yachts Cup was the first one where the rating was based on ORC, to find the fairest way to rate every boat itself.

This caused to very close positions at the leader board and very exiting racing on the water.

Oliver Leu thanked all the sailors, sponsors and supporters for the help to organize such an event.

The later Sunday evening was a great party for everybody to talk about the experiences and have a drink or two.

Osteecup Results

X-332 "Quattro" - Klaus-Peter Brook - 1st Sport Class A

X-41 "Sydbank" - Torsten Bastiansen - 1st Sport Class B

X-37 "Paxi" - Dr. Gerd Blettenberg - 1st Family Class A

X-43 "She" - Thorsten Schauer - 1st Family Class B



X-Yachts Holland Cup

Marina Muiderzand, 28 - 29 May 2016



On the weekend of 28 - 29 May 18 X-Yachts met at Marina Muiderzand for the 2016 X-Yachts Holland Cup.

drinks from the sponsors. The prize giving ceremony followed with music and drinks that was enjoyed by all the crews.

Next year the Holland X-Cup will be held on 20th - 21st May. We look forward to seeing you there for another great weekend of racing!

Run Alongside the Almere Regatta, the Holland X-Cup is always a firm favourite amongst X-Yacht owners.

With 18 X-Yachts racing in the family class and 7 in the sports class the X-Yachts fleet enjoyed perfect sailing conditions of 15 knots of wind and sunshine.

On day one both classes sailed 2 races with Victor Lendering's X-412 "The Fox" winning race 1 and Erwin Sikking's X-382 "X-Zone" winning race 2 in the family class. In the Sport Class OWNERS NAME "BOAT NAME" won race 1 and OWNERS NAME "BOAT NAME" won race 1 and

Day 2 saw a little more wind on the course and some competitive racing from both fleets. "BOAT NAME" won race 3 in the family class and "Boat NAME" in the sport class, meaning that the overall winner for the 2016 Holland X-Cup were XoGood for Sport Class and "The Fox" in the Family Class.

In the evening the crews enjoyed a shore side BBQ in the sunshine along with

Holland Cup Results

X-43 "XoGood" - Erwin Goede - 1st Sport Class

X-412 "The Fox" - Victor Lendering - 1st Family Class



X-Yachts Carnival in Marmaris

Great atmosphere and phenomenal results for the X-Yachts participating in this year's Marmaris International Race Week.



Brand new Xp 33 'Xtreme 2' 3rd classified in IRC 2.

The beautiful city of Marmaris in Southwest Turkey witnessed a spectacular event again in the last days of the 2016 season.

The 27th of the traditional five-days long Marmaris International Race Week (MIRW), organised by the Marmaris International Yacht Club (MIYC) brought together 91 competing boats and hundreds of sailors from USA, Germany, Russia, Bulgaria, Great Britain, Ukraine, Denmark, The Netherlands, Greece, Belarus, Austria, Romania, and

Turkey. Only 21 of the participating boats being Turkish, MIRW once again deserved the adjective "International" in its title.

With all planned races (2 inshore, 2 offshore, 1 coastal race) having been run without cancellations, 2016's MIRW was enjoyed by all sailors. Ever changing sea and weather conditions indigenous to the unique geographical setting of Marmaris, tested crews and yachts well, making every bit of the races enjoyable for racers and spectators alike.

Five X-Yachts were registered in this 27th Race Week, and those have achieved some phenomenal results and virtually turned the event into an X-Yachts carnival.

The exclusive distributor of X-Yachts in Turkey co-sponsored three out of five boats, and provided them with technical and logistical support and assistance through their Certified X-Yachts Technical Service Centre based in Marmaris.

With a total of 10 trophies been won between them, these three boats of X-Yachts Turkey

fleet dominated the podium which they occupied one after another, receiving 6 trophies in a row at the last day's prizegiving which included the overall results as well.

The Xp 38 "Extreme Ways", skippered by Andrew J. Holdsworth, already being the overall winner of MIRW 2014, overwhelmed the ambitious opponents from other brands, securing the 1st place in 4 races, coming 2nd in only one, and comfortably becoming 1st in overall.

The multi-national, young, and disciplined crew of "Extreme Ways" proved that their victory at the same event back in 2014 was no coincidence. They now look forward to racing in Marmaris again next year.

Another X-Yachts Turkey fleet member, the X-41 "Fox", skippered by Oleg Mustafaev, was always right behind Xp 38 "Extreme Ways" in close-fought races.

In order to prepare for MIRW, the crew of "Fox" had been training and participating small local regattas in Turkey since the previous season. Their efforts paid off wondrously when they

won the 2nd in overall in IRC I, securing the 2nd and 3rd places in two of the five races. Two splendid, well-deserved "first finishes" was the icing on top.

In IRC II, owner Niels Schoenrock won the 1st race and came 2nd in another, missing the podium with seconds in others with his boat "Xtreme", his third X-Yachts but the very first Xp 33 in Turkey, which had just been delivered to her owner two months before MIRW.

Despite the relatively young and inexperienced crew on board, "Xtreme" passed her first big test by securing the 3rd place in overall, ahead of serious opponents sailed by some of the most talented professional sailors in Turkey.

"Xtreme's" boat-to-boat competition with her nearest opponent, a MAT1010, was particularly breathtaking.

Having proven itself in a serious widescale international races, the Xp 33 has now a very promising future in Turkish racing arena as well.



MIRW 2017 X-Yachts Results

Xp 38 "Extreme Ways" - Andrew Holdsworth - 1st IRC1

X-41 "Fox" - Oleg Mustafaev - 2nd IRC1

Xp 33 "Xtreme 2" - Niels Schoenrock - 3rd IRC2

X-35 "LZ Yachting" - Lachezar Bratoev - 6th IRC2

X-412 "La Loba" - Yuriy Goncharov, SK Yachting - 5th IRC CP



LEADING THE FLEET WITH COMPOSITE MATERIALS

Over the past thirty five years, Gurit has proven itself as a leading supplier of composite materials and solutions to the marine sector, from sport fishing to patrol boats, high-end race yachts to production launches and luxury superyachts to home-build kits.

With regionally located production sites, sales offices and engineering support as well as a vast global network of business partners and distributors, Gurit will ensure the success of your project.



Gurit is proud to supply its PRIME™ 27 Epoxy Infusion System, Spabond 540LV Adhesive and Corecell™ Structural Foam Core to X-Yachts' full line of XPerformance and XRange performance cruisers.

For more information on Gurit's full composite offering and expertise: www.gurit.com





Xp 38 "Extreme Ways" Winner in IRC 1.

Another X-Yachts competing in IRC II in this year's MIRW was the Bulgarian X-35 "LZ Yachting", skippered by Lachezar Bratov.

"LZ Yachting" is no stranger to the Turkish sailing scene. The boat had previously won the Bosphorus Cup 2016 organised in Istanbul.

Always in higher ranks, "LZ Yachting" finished one of the races in 2nd place, and showed that an X-Yachts should never be underestimated.

Since the first time it was organised, and over the years, Marmaris International Race Week has increasingly evolved from just a series of races into a sailing festival enjoyed by more than 1.000 sailors as well as their friends and families.

Prize giving ceremonies with open buffet dinners take place in a big festival tent specifically put up for the event.

Live music and professional video shows with highlights of the day cheers up the atmosphere, making this a happy,

memorable event which makes people want to come back the next year.

X-Yachts congratulates these winning skippers and crews, and also praises their exclusive Turkey distributor for their efforts to co-sponsor and to technically back up their winning fleet through their Marmaris Technical Service Centre.



"Xtreme 2" crew celebrating their place on the podium.



OFFICIAL SUPPLIER FOR STEERING SYSTEMS (XP RANGE)



SOLIMAR
MARINE EQUIPMENT

Meet the team

 <p>Australia X-Yachts Australia Pty Ltd www.x-yachts.net.au Tel: + 61 (0) 2 9719 9411 Mob: +61 (0) 414 645 259 ap@x-yachts.net.au</p> <p><i>Andrew Parkes</i></p>	 <p>Estonia · Latvia · Lithuania X-Yachts Baltic Ltd. www.x-yachts.ee Mob: +372 565 2868 marko@x-yachts.ee</p> <p><i>Marko Manni</i></p>	 <p>Germany X-Yachts Deutschland www.x-yachts.de Tel: +49 (0)461 4 30 20 99 0 cbarth@x-yachts.de</p> <p><i>Christoph Barth</i></p>
 <p>Belgium · Singapore X-Yachts Belgium www.x-yachts.be Tel: +32 475 287 162 ev@x-yachts.be</p> <p><i>Eddy Verbinnen</i></p>	 <p>Mob: +372 5649 5589 mati@x-yachts.ee</p> <p><i>Mati Sepp</i></p>	 <p>Agentur Lübecker Bucht Tel: +49 (0) 43 62 90 06 44 leu@x-yachts.de</p> <p><i>Oliver Leu</i></p>
 <p>Bulgaria · Romania ELS Sailing & Services www.elsbg.com Tel: +359 52 301 075 Mob: +359 878 444 584 pdukov@elsbg.com</p> <p><i>Pavel Dukov</i></p>	 <p>Finland X-Yachts Finland Oy Ab www.x-yachts.fi Tel: +358 40 4142 545 robi@x-yachts.fi</p> <p><i>Robi Gripenberg</i></p>	 <p>Holland X-Yachts Holland www.x-yachts.nl Tel: +31 (0) 36 536 9057 info@x-yachts.nl</p> <p><i>Nanno Schuttrups</i></p>
 <p>Canada Fraser Yacht Sales Ltd Tel: +1 604 377 4773 ian@fraseryachtsales.com</p> <p><i>Ian Fraser</i></p>	 <p>France X-Yachts France www.x-yachts.fr Tel: +33 (0) 494 45 37 33 Fax: +33 (0) 494 45 52 60 contact@x-yachts.fr</p> <p><i>Jean-Luc Chalant</i></p>	  <p><i>Nikki Schuttrups</i> <i>Rob Schuttrups</i></p>
 <p>Chile · Peru Windmade Spa Tel: +562 2980 7079 Mob: +569 6844 3347 ventas@windmade.cl ventas@windmade.pe</p> <p><i>Juan E. Reid</i></p>	<p>West Mediterranean: CAP Yachting Tel: +33 (0) 466 51 33 11 · languedoc@x-yachts.fr Atlantic: Aventure Océane Tel: +33 (0) 688 05 12 66 · atlantic@x-yachts.fr Brittany: Arzal Nautique Tel: +33 (0) 297 45 03 52 · bretagne@x-yachts.fr Normandy: SNIP Yachting Tel: +33 (0)231 97 34 47 · wnormandie@x-yachts.fr</p>	 <p>Hong Kong X-Yachts Hong Kong Tel: +852 2789 7828</p> <p>Mob: +852 9473 4098 richard@22northhk.com</p> <p>Mob: +852 9457 3573 russ@22northhk.com</p> <p><i>Richard Strompf</i></p>
 <p>China Qingdao Furi Yachts & Marina Club Co www.china.x-yachts.com Tel: +86 0186 789 66930 Mob: +86 0532 55663333 zhxr@furigroup.com.cn</p> <p><i>Anna Zhang</i></p>	 <p>Great Britain · Ireland X-Yachts (GB) Ltd - England www.x-yachtsgb.com Tel: +44 (0) 23 8045 3377 info@x-yachtsgb.com</p> <p><i>Conor Fanning</i></p>	 <p><i>Russ Parker</i></p>
 <p>Denmark X-Yachts Denmark www.x-yachts.com Tel: +45 74 52 10 22 cdh@x-yachts.com</p> <p><i>Christian Due Hammershoy</i></p>	  <p><i>Stuart Abernethy</i> <i>Debbie Weldon</i></p> <p>X-Yachts (Group) Ltd - Ireland www.x-yachtsireland.com Tel: +353 (0) 1 855 8077 info@x-yachtsireland.com</p>	 <p>Hungary Westport Company Kft. www.west-port.eu Tel: +36 1 3458 158 Mob: +36 30 / 9382 946 x-yachts@west-port.eu</p> <p><i>Tibor Bednar</i></p>
 <p>Dubai X-Yachts Dubai www.x-yachts.com Tel: +971 50 624 2750 XYachtsDubai@mailme.ae</p> <p><i>Phil Ellerby</i></p>	 <p>Greece Atalanta Marine www.atalantamarine.com Tel: +30 210 99 10 722 shipyards@atalantamarine.com</p> <p><i>George Ertzos</i></p>	 <p>Italy X-Italia srl. www.x-italia.it Tel: +39 0185 308 615 info@x-italia.it</p> <p><i>Fabio & Giulia Baffigi</i></p>
<p><i>Phil Ellerby</i></p>	<p><i>George Ertzos</i></p>	 <p>Southern Italy Mob: +39 348 8595478 hmp.xyacs@gmail.com</p> <p><i>Carlo Colabucci</i></p>

INVITATION

to the biggest X-Yachts event in the World



Sport classes. Family classes. Over 50 ft. Class.
X-35 World Championship.

x

Dinner and social entertainment every night at the Royal Danish Yacht Club
in Skovshoved Harbour, Copenhagen.

x

Pre-register your interest online at www.x-yachts.com, official entry opens on
February 1, 2017. A limited number of spaces are available, so register as soon as
you can to ensure you don't miss out!





Israel
X-Yachts Israel
www.x-yachts.co.il
Tel: +972 3 5244 333
Mob: +972 544 987540
info@x-yachts.co.il



**Slovenia • Croatia •
Bosnia Herzegovina
Macedonia • Montenegro**
X-Yachts Jadran d.o.o.
www.x-yachts.si
Tel: +386 41 730 970
x-yachts-jadran@siol.com



Thailand
X-Yachts Thailand
www.solidair.asia
Tel: +66 (0) 888469670
lance@solidair.asia



Japan
135 East Co Ltd.
www.135-e.com
Tel: +81 (0) 798 32 1350
info@135-e.com



South Africa
X-Yachts South Africa
Tel: +27 (0) 834 599 553
neville.poulter@shadowdm.com



Turkey
X-Yachts Türkiye
www.x-yachts.com.tr
Tel: +90 212 318 0129
Mob: +90 533 465 4416
info@x-yachts.com.tr



Malta
Sail Power Ltd.
www.x-yachts.com.mt
Tel: +356 21 360901
Timmy Mob: +356 7949 4500
Angela Mob: +356 99360901
info@sailpower.com.mt



Spain
X-Yachts Spain
www.x-yachts.es
Mob: +34 691 390 958
soren@x-yachtsspain.com



Andalucía & Valencia
Mob: +34 670 557 349
iñaki@x-yachtsspain.com



New Zealand
Allboat Brokerage Ltd
Tel + 64 (9) 360 8532
Mobile +64 (0) 21 966 178
terry@allboat.co.nz



Sweden
X-Yachts Sweden
www.x-yachts.se
Tel: +46 703172669
johan@x-yachts.se



Ukraine
X-Yachts Ukraine
Tel: +38 067 501 9608



Norway
X-Yachts Norge AS
www.x-yachts.no
Tel: +47 40 00 33 80
post@x-yachts.no



**Switzerland • Austria •
South Germany**
Switzerland & Austria
www.x-yachts.ch
office@x-yachts.ch
X-Yachts Marine GmbH
Tel: +41 (0) 71 680 05 36
X-Yachts Marine Sàrl
Tel: +41 (0) 21 510 22 07



USA
X-Yachts USA
www.x-yachtsusa.com
Tel: +1 860 536 7776
Mob: +1 860 625 3898
rbr@x-yachtsusa.com
th@x-yachtsusa.com



Portugal • Brazil
X-Yachts Portugal
Tel: +351 219 244 774
Mob: +351 916 761 859
topematos@hotmail.com



South Germany
X-Yachts Marine GmbH
www.xyachts.de
Tel: +49 (0) 7531 58 40 42
info@x-yachts.ch



Cheasapeake
Forbes Horton Yachts
www.forbesyachts.com
Tel: +1 (410) 268-2337



Russia
X-Yachts Russia Moscow
www.x-yachts.ru
Mob: +791 6400 1305
ag@x-yachts.ru
Andris Mob: +371 2923 9906
az@x-yachts.ru



Taiwan
Taiwan Marine Service
Co. Ltd
www.twmarine.com.tw
Tel: +886-7-5510500
Fax: +886-7-5510600



Charleston, South Carolina
Ashley Yachts
www.ashleyyachts.com
Tel: +1 (843) 577-7222

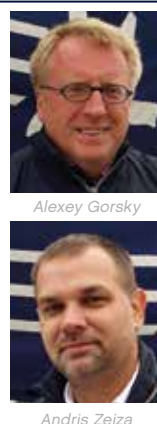

X-Yachts Great Lakes
Tel: +920 682-5117
rlarsen@manitowoc-marina.com



X-Yachts California
Tel: +1 (949) 933-8329



X-Yachts Great Lakes
Tel: +920 682-5117
rlarsen@manitowoc-marina.com



GO BEYOND™ BOUNDARIES

3Di™
Moulded
Composites

THE PERFECT MATCH

Since 1978, X-Yachts and North Sails have shared a mission to produce superior yachts outfitted with the highest quality sails available. World-class yachts and world-class sails unite to offer outstanding value plus victory on the race course.